

Draft **ETSI EN 300 253** V2.1.11 (2015-01)



**Environmental Engineering (EE);
Earthing and bonding of ICT equipment powered by -48 VDC in
telecom and data center**

Reference

REN/EE-0250

Keywords

bonding, earthing, equipment practice

ETSI

650 Route des Lucioles
F-06921 Sophia Antipolis Cedex - FRANCE

Tel.: +33 4 92 94 42 00 Fax: +33 4 93 65 47 16

Siret N° 348 623 562 00017 - NAF 742 C
Association à but non lucratif enregistrée à la
Sous-Préfecture de Grasse (06) N° 7803/88

Important notice

The present document can be downloaded from:

<http://www.etsi.org>

The present document may be made available in electronic versions and/or in print. The content of any electronic and/or print versions of the present document shall not be modified without the prior written authorization of ETSI. In case of any existing or perceived difference in contents between such versions and/or in print, the only prevailing document is the print of the Portable Document Format (PDF) version kept on a specific network drive within ETSI Secretariat.

Users of the present document should be aware that the document may be subject to revision or change of status. Information on the current status of this and other ETSI documents is available at

<http://portal.etsi.org/tb/status/status.asp>

If you find errors in the present document, please send your comment to one of the following services:

http://portal.etsi.org/chaicor/ETSI_support.asp

Copyright Notification

No part may be reproduced or utilized in any form or by any means, electronic or mechanical, including photocopying and microfilm except as authorized by written permission of ETSI.

The content of the PDF version shall not be modified without the written authorization of ETSI.

The copyright and the foregoing restriction extend to reproduction in all media.

© European Telecommunications Standards Institute 2015.

All rights reserved.

DECT™, **PLUGTESTS™**, **UMTS™** and the ETSI logo are Trade Marks of ETSI registered for the benefit of its Members. **3GPP™** and **LTE™** are Trade Marks of ETSI registered for the benefit of its Members and of the 3GPP Organizational Partners.

GSM® and the GSM logo are Trade Marks registered and owned by the GSM Association.

Contents

Intellectual Property Rights	4
Foreword.....	4
Modal verbs terminology.....	5
Introduction	5
1 Scope.....	6
2 References	6
2.1 Normative references	6
2.2 Informative references.....	7
3 Definitions and abbreviations.....	7
3.1 Definitions.....	7
3.1.1 IEC definitions (by IEC 60050 numbers)	7
3.1.2 Telecommunication definitions	8
3.2 Abbreviations	9
4 General requirements	10
4.1 Safety from electrical hazards	10
4.2 Signal reference.....	10
4.3 EMC performance	10
5 Requirements on bonding networks	10
5.1 Bonding configurations	10
5.2 CBN within a telecommunication building or data centre	10
5.3 BN within a telecommunication or ICT system	11
5.4 Merging of CBN and MESH-BNs	14
5.5 Cabling within and between BNs	14
6 Requirements for power distribution.....	14
6.1 DC power distribution of secondary supply	14
6.2 DC power distribution of tertiary supplies	14
6.3 AC mains distribution and bonding of the protective conductor.....	15
6.4 AC power distribution from tertiary power supply	15
Annex A (normative): Rationale about CBN co-ordination.....	16
Annex B (informative): Rationale about the integration of the DC return conductor into the merged CBN/MESH-BN	18
Annex C (normative): AC mains distribution and bonding of the protective conductor.....	20
Annex D (informative): Bibliography	24
History	25

Intellectual Property Rights

IPRs essential or potentially essential to the present document may have been declared to ETSI. The information pertaining to these essential IPRs, if any, is publicly available for **ETSI members and non-members**, and can be found in ETSI SR 000 314: "*Intellectual Property Rights (IPRs); Essential, or potentially Essential, IPRs notified to ETSI in respect of ETSI standards*", which is available from the ETSI Secretariat. Latest updates are available on the ETSI Web server (<http://ipr.etsi.org>).

Pursuant to the ETSI IPR Policy, no investigation, including IPR searches, has been carried out by ETSI. No guarantee can be given as to the existence of other IPRs not referenced in ETSI SR 000 314 (or the updates on the ETSI Web server) which are, or may be, or may become, essential to the present document.

Foreword

This draft European Standard (EN) has been produced by ETSI Technical Committee Environmental Engineering (EE), and is now submitted for the combined Public Enquiry and Vote phase of the ETSI standards EN Approval Procedure.

The present document has been produced within the framework of the following considerations:

- a) ICT equipment is generally installed in telecommunication or data centres and held in racks, cabinets or other mechanical structures;
- b) the existing Recommendation ITU-Ts and CENELEC standards in such matters do not ensure the required standardization at the equipment level;
- c) network operators and equipment providers agreed to standardize on a bonding configuration that facilitates:
 - compliance with functional requirements including Electromagnetic Compatibility (EMC) aspects of emission and immunity;
 - compatible building and equipment provisions;
 - installation of new telecommunication or data centres as well as expansion or replacement of installations in existing telecommunication or data centres with equipment coming from different suppliers;
 - a structured installation practice;
 - simple maintenance rules;
 - contracting on a common basis;
 - cost effectiveness in development, manufacturing, installation and operation.

Proposed national transposition dates	
Date of latest announcement of this EN (doa):	3 months after ETSI publication
Date of latest publication of new National Standard or endorsement of this EN (dop/e):	6 months after doa
Date of withdrawal of any conflicting National Standard (dow):	6 months after doa

Modal verbs terminology

In the present document "**shall**", "**shall not**", "**should**", "**should not**", "**may**", "**may not**", "**need**", "**need not**", "**will**", "**will not**", "**can**" and "**cannot**" are to be interpreted as described in clause 3.2 of the [ETSI Drafting Rules](#) (Verbal forms for the expression of provisions).

"**must**" and "**must not**" are **NOT** allowed in ETSI deliverables except when used in direct citation.

Introduction

The present document addresses earthing and bonding of ICT equipment in telecommunication or data centres in relation to safety, functional performance and EMC.

Information regarding the general principles on earthing for telecommunication or data centres has been published by the ITU-T in the handbook on "Earthing of telecommunication installations" [i.1]. Recommendation ITU-T K.27 [i.2] deals with bonding configurations and earthing inside a telecommunication building or data centre. One bonding configuration only is selected from Recommendation ITU-T K.27 [i.2] (CBN/MESH-BN) and tailored to the present document.

The author thanks the International Electrotechnical Commission (IEC) for permission to reproduce Information from its International Standard IEC 60364-1 (CENELEC HD 60364-1 [i.11]) ed. 5.0 (2005). All such extracts are copyright of IEC, Geneva, Switzerland. All rights reserved. Further information on the IEC is available from www.iec.ch. IEC has no responsibility for the placement and context in which the extracts and contents are reproduced by the author, nor is IEC in any way responsible for the other content or accuracy therein.

1 Scope

The present document applies to earthing and bonding of ICT equipment operating with DC voltage defined in ETSI EN 300 132-2 [i.9], in order to facilitate the installation, operation and maintenance of equipment.

It also co-ordinates with the pre-conditions of the installation to achieve the following targets:

- safety from electrical hazards;
- reliable signal reference;
- satisfactory Electromagnetic Compatibility (EMC) performance.

The specification of ICT equipment and of the pre-conditions of installation are subject to agreement of the parties (e.g. the supplier and the purchaser) and the procedure to achieve agreement is covered by annex A of the present document.

The present document does not cover safety and EMC aspects of the equipment. Those aspects are covered by other relevant standards.

The present document does not apply to the installation of ICT equipment in locations other than telecommunication and data centres, e.g. ICT equipment within a customer's building, including subscriber line termination.

NOTE: Earthing and bonding of equipment installed in locations other than telecommunication and data centres is covered by CENELEC EN 50310 [i.6].

2 References

2.1 Normative references

References are either specific (identified by date of publication and/or edition number or version number) or non-specific. For specific references, only the cited version applies. For non-specific references, the latest version of the reference document (including any amendments) applies.

Referenced documents which are not found to be publicly available in the expected location might be found at <http://docbox.etsi.org/Reference>.

NOTE: While any hyperlinks included in this clause were valid at the time of publication, ETSI cannot guarantee their long term validity.

The following referenced documents are necessary for the application of the present document.

- [1] CENELEC HD 60364-4-41: "Low-voltage electrical installations - Part 4-41: Protection for safety - Protection against electric shock".
- [2] CENELEC HD 60364-5-54: "Low-voltage electrical installations - Part 5-54: Selection and erection of electrical equipment - Earthing arrangements, protective conductors and protective bonding conductors".
- [3] CENELEC EN 60950-1: "Information technology equipment - Safety - Part 1: General requirements".
- [4] CENELEC EN 41003: "Particular safety requirements for equipment to be connected to telecommunication networks and/or a cable distribution system".

2.2 Informative references

References are either specific (identified by date of publication and/or edition number or version number) or non-specific. For specific references, only the cited version applies. For non-specific references, the latest version of the reference document (including any amendments) applies.

NOTE: While any hyperlinks included in this clause were valid at the time of publication, ETSI cannot guarantee their long term validity.

The following referenced documents are not necessary for the application of the present document but they assist the user with regard to a particular subject area.

- [i.1] ITU-T handbook: "Earthing of telecommunication installations".
- [i.2] Recommendation ITU-T K.27 (1991): "Bonding Configurations and Earthing inside a Telecommunication Building".
- [i.3] IEC 60050: "International Electrotechnical Vocabulary".
- [i.4] IEC 60050-604: "International Electrotechnical Vocabulary. Chapter 604: Generation, transmission and distribution of electricity - Operation".
- [i.5] IEC 60050-826: "International Electrotechnical Vocabulary. Electrical installations of buildings".
- [i.6] CENELEC EN 50310: "Application of equipotential bonding and earthing in buildings with information technology equipment".
- [i.7] CENELEC EN 62305 series: "Protection against lightning".
- [i.8] IEC 60050-195: "International Electrotechnical Vocabulary. Electrical installations of buildings". Earthing and protection against electric shock.
- [i.9] ETSI EN 300 132-2: "Environmental Engineering (EE); Power supply interface at the input to telecommunications and datacom (ICT) equipment; Part 2: Operated by -48 V direct current (dc)".
- [i.10] CENELEC EN 50162: "Protection against corrosion by stray current from d.c. system".
- [i.11] CENELEC HD 60364-1: "Electrical installation of buildings; Part 1: Scope, object and definitions".

3 Definitions and abbreviations

3.1 Definitions

For the purposes of the present document, the following terms and definitions apply.

The following definitions with respect to earthing and bonding are introduced by the IEC 60050 [i.3] and are used within the present document to maintain conformity.

3.1.1 IEC definitions (by IEC 60050 numbers)

NOTE: IEC 60050 [i.3] references are given in parentheses (see IEC 60050-604 [i.4], IEC 60050-826 [i.5] and IEC 60050-195 [i.8]).

earth (195-01-03): part of the Earth which is in electric contact with an earth electrode and the electric potential of which is not necessarily equal to zero earthing arrangement

earthing conductor (195-02-03): conductor which provides a conductive path, or part of the conductive path, between a given point in a system or in an installation or in equipment and an earth electrode

earth electrode (195-02-01): conductive part, which may be embedded in a specific conductive medium, e.g. concrete or coke, in electric contact with the Earth

earthing network (604-04-07): part of an earthing installation that is restricted to the earth electrodes and their interconnections

equipotential bonding (195-01-10): provision of electric connections between conductive parts, intended to achieve equipotentiality

main earthing terminal (826-13-15): terminal or busbar which is part of the earthing arrangement of an installation and enabling the electric connection of a number of conductors for earthing purposes

Neutral conductor (N) (826-01-03): conductor connected to the neutral point of a system and capable of contributing to the transmission of electrical energy

PEN conductor (826-13-25): conductor combining the functions of both a protective earthing conductor and a neutral conductor

protective earthing conductor (PE) (826-13-23): protective conductor provided for protective earthing

IT, TN-C, TN-S, and TT systems (see HD 60 364-1: The codes used have the following meanings:

First letter – Relationship of the power system to earth:

T = direct connection of one point to earth;

I = all live parts isolated from earth, or one point connected to earth through a high impedance.

Second letter – Relationship of the exposed-conductive-parts of the installation to earth:

T = direct electrical connection of exposed-conductive-parts to earth, independently of the earthing of any point of the power system;

N = direct electrical connection of the exposed-conductive-parts to the earthed point of the power system

Subsequent letter(s) (if any) – Arrangement of neutral and protective conductors:

S = protective function provided by a conductor separate from the neutral conductor or from the earthed line conductor.

C = neutral and protective functions combined in a single conductor (PEN conductor).

3.1.2 Telecommunication definitions

The following definitions, specific to telecommunication or data centre installations and not covered by the IEC 60050 [i.3], are used within the present document. Correspondence to Recommendation ITU-T K.27 [i.2] is indicated as appropriate.

bonding mat: essential means to provide a SRPP by a discernible, nearly regular mesh structure

NOTE: The bonding mat may be located either below or above a collection of equipment constituting a system block.

Bonding Network (BN), (Recommendation ITU-T K.27 [i.2]): set of interconnected conductive structures that provides an "electromagnetic shield" for electronic systems and personnel at frequencies from Direct Current (DC) to low Radio Frequency (RF)

NOTE: The term "electromagnetic shield" denotes any structure used to divert, block or impede the passage of electromagnetic energy. In general, a BN need not be connected to earth but all BNs considered in the present document will have an earth connection.

Common Bonding Network (CBN), (Recommendation ITU-T K.27 [i.2]): principal means for effective bonding and earthing inside a telecommunication building or data centre

NOTE: It is the set of metallic components that are intentionally or incidentally interconnected to form the principal BN in a building. These components include: structural steel or reinforcing rods, metallic plumbing, Alternating Current (AC) power conduit, PE conductors, cable racks and bonding conductors. The CBN always has a mesh topology and is connected to the earthing network.

DC return conductor: (+) conductor of the -48 V or -60 V secondary DC supply

ICT equipment: equipment designed for Information and Communication Technologies

NOTE: It is similar to Information Technology (IT), but focuses primarily on communication technologies. This includes the Internet, wireless networks, cell phones, and other communication mediums.

MESHed Bonding Network (MESH-BN), (Recommendation ITU-T K.27 [i.2]): bonding network in which all associated equipment frames, racks and cabinets and usually the DC power return conductor, are bonded together as well as at multiple points to the CBN

NOTE 1: Consequently, the MESH-BN augments the CBN.

NOTE 2: See figure 1 of the present document.

MESHed Isolated Bonding Network (MESH-IBN), (Recommendation ITU-T K.27 [i.2]): type of IBN in which the components of the IBN (e.g. equipment frames) are interconnected to form a mesh-like structure

NOTE: This may, for example, be achieved by multiple interconnections between cabinet rows, or by connecting all equipment frames to a metallic grid (a "bonding mat") extending beneath the equipment. The bonding mat is, of course, insulated from the adjacent CBN. If necessary the bonding mat could include vertical extensions, resulting in an approximation to a Faraday cage. The spacing of the grid is chosen according to the frequency range of the electromagnetic environment.

power supply:

- **primary supply:** public mains or, under emergency conditions, a locally generated AC supply
- **secondary supply:** supply to the ICT equipment, racks or system block, derived from the primary supply
- **tertiary supplies:** supplies to the ICT equipment, derived from the secondary supply

system: regularly interacting or interdependent group of items forming a unified whole

system block: functional group of equipment depending in its operation and performance on its connection to the same system reference potential plane, inherent to a MESH-BN

System Reference Potential Plane (SRPP): conductive solid plane, as an ideal goal in potential equalizing, is approached in practice by horizontal or vertical meshes

NOTE 1: The mesh width thereof is adapted to the frequency range to be considered. Horizontal and vertical meshes may be interconnected to form a grid structure approximating to a Faraday cage.

NOTE 2: The SRPP facilitates signalling with reference to a common potential.

3.2 Abbreviations

For the purposes of the present document, the following abbreviations apply:

AC	Alternating Current
BN	Bonding Network
CBN	Common Bonding Network
DC	Direct Current
EMC	ElectroMagnetic Compatibility
LPS	Lightning Protection System
MESH-BN	MESHed Bonding Network
MESH-IBN	MESHed Isolated Bonding Network
N	Neutral conductor
PE	Protective Earth conductor
PEN	combined Protective Earth and Neutral conductor
RF	Radio Frequency
SRPP	System Reference Potential Plane

4 General requirements

4.1 Safety from electrical hazards

To achieve safety the standards EN 60950-1 [3], EN 41003 [4] and CENELEC HD 60364-4-41 [1] shall be applied in the design of the equipment. The installation of PEs and equipotential bonding conductors shall be carried out in accordance with CENELEC HD 60364-5-54 [2].

The conductors involved shall provide sufficiently high current conducting capability and low impedance according to the relevant safety standards to avoid electric shock, risk of fire, or damage to the equipment under normal or faulty operating conditions within an equipment or the distribution network, or due to the impact of induced voltage and current, e.g. by lightning.

4.2 Signal reference

Reliable signal reference shall be provided by a SRPP dedicated at least to a functional unit or a system block. To avoid undue functional distortion or risk of component failure, the SRPP shall provide sufficiently low impedance up to the highest frequency to be regarded by using a metal plane or a meshed configuration having adequate mesh dimensions, e.g. a bonding mat. The frequency band to be covered shall include the spectral components of transients caused by switching, short circuits and atmospheric discharges.

NOTE: Signal reference to the SRPP does not always imply signal return via the SRPP.

4.3 EMC performance

Measures to gain a satisfactory EMC performance shall be assisted by a SRPP. The SRPP shall provide sufficiently low impedance for efficient connection of filters, cabinets and cable shields. The requirement to avoid undue emission of, or susceptibility to electromagnetic energy under normal operating conditions may govern the properties of the SRPP ahead of what is required in clause 4.2. The EMC requirements addressed include the discharge of electrostatic energy.

5 Requirements on bonding networks

5.1 Bonding configurations

Bonding configurations can be addressed at a building level (i.e. CBN), at an installation level (i.e. merging of CBN and MESHed Bonding Network (MESH-BN)) and at an equipment level (i.e. MESH-BN).

Recommendation ITU-T K.27 [i.2] deals with bonding configurations of ICT equipment at a building and installation level. Regarding the bonding configuration at an equipment level a MESH-BN is explicitly distinguished in the present document.

5.2 CBN within a telecommunication building or data centre

Telecommunication building or data centre shall be provided with a CBN having sufficiently low impedance and high current conducting capability to meet the general requirements of clause 4. The earthing conductor and the equipotential bonding conductors should be coloured in accordance to international and national regulations.

The main earthing terminal of the CBN shall be extended by a bonding ring conductor along the inside perimeter of the building, or a ring conductor, as a basic element of the CBN, shall at least comprise a system block by its outer perimeter. A growth by extension of the telecommunication or ICT installation inside a building or a data centre requires such a minimum CBN version to be augmented into a three dimensional grid structure, approximating a Faraday cage (see figure 1). The impact of interfering energy in an exposed location or the need for information security enforces the provision of shielded rooms as a maximum requirement to the CBN.

Annex A gives information about the implementation principles for the CBN, thereby following Recommendation ITU-T K.27 [i.2], clause 4.2.1.

5.3 BN within a telecommunication or ICT system

Within a telecommunication or ICT system, especially a system block, the BN shall be of the mesh type. The MESH-BN shall provide sufficiently low impedance and high current conducting capability to meet the general requirements in clause 4.

The MESH-BN shall interconnect shelves, cabinets, rack rows, cable racks, ducts, troughs, distribution frames, cable shields and bonding mat to constitute the required SRPP.

All metallic parts of the MESH-BN shall form an electrically continuous whole. This does not necessarily require bonding by additional bonding straps, but that improvements should be taken into account when determining the finishes and fastening methods to be used. The mechanical structure comprised by the MESH-BN shall form part of the SRPP.

As an example, figure 2 addresses interconnections within a system block, essential to a MESH-BN. This example follows the implementation principles for the MESH-BN outlined in Recommendation ITU-T K.27 [i.2], clause 4.2.2.

The cable shields shall be connected to the rack.

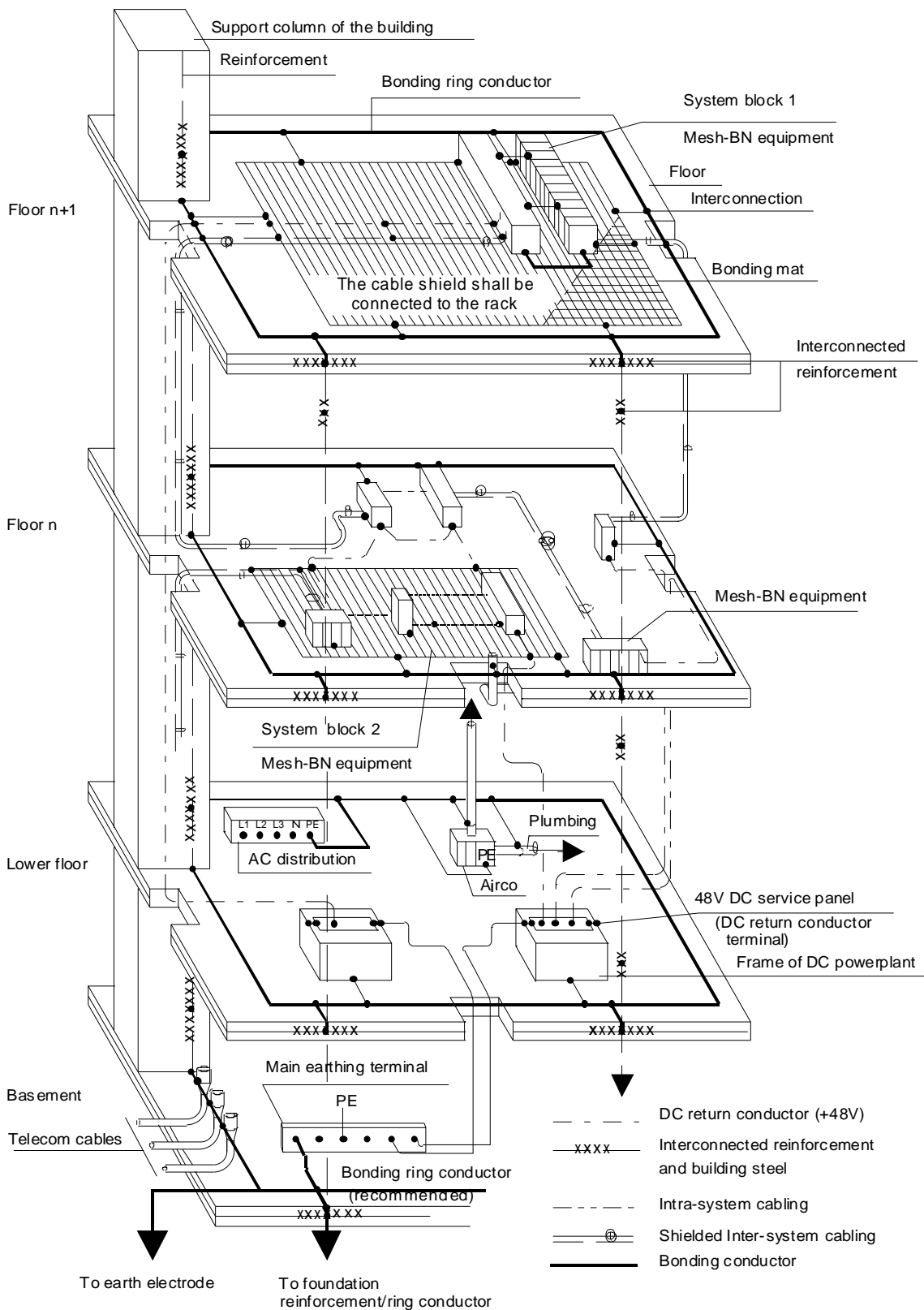

Figure 1: Example of a CBN/MESH-BN installation inside a telecommunication building or data centre

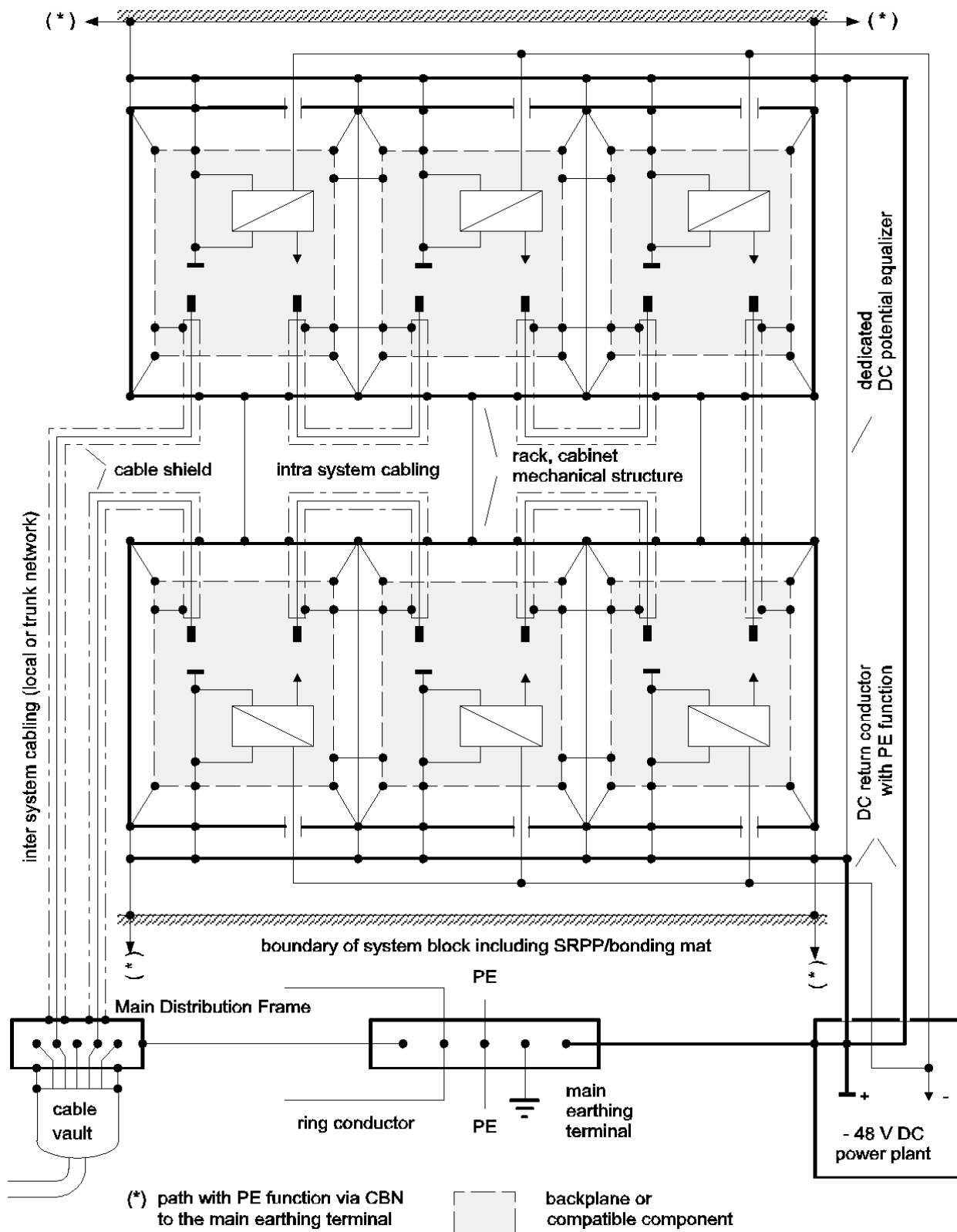

Figure 2: Example of a CBN/MESH-BN configuration with common DC return conductor connected to the CBN at multiple points

5.4 Merging of CBN and MESH-BNs

All BNs of telecommunication or ICT systems and their associated DC return conductors shall be connected to the CBN.

The MESH-BN shall augment the CBN including the main earthing terminal by multiple interconnections to the CBN (see figures 1 and 2).

5.5 Cabling within and between BNs

Power distribution cables and signal cables within and between MESH-BNs shall be run tightly along the members of the augmented CBN.

There shall be a separation distance of at least 100 mm between cable tracks of AC mains cables and signal cables, unless adequate shielding is provided.

Cable shields shall be bonded directly to racks, cabinets or to the dedicated SRPP at least at each end. Circumferential connections are most effective and therefore are recommended.

NOTE: It is recognized that where a new system has to be cabled to existing equipment, it has previously been considered feasible to avoid the connection of cable shields at the existing equipment end. However, the consequent solution of the present document is to provide a lower impedance path via improved bonding between the equipment locations, thereby enabling connection of cable shields at least at each end.

6 Requirements for power distribution

6.1 DC power distribution of secondary supply

The DC power distribution shall use (+) and (-) conductors routed close together. Each DC return conductor serving a telecommunication or ICT system shall be bonded to the CBN at least at the main earthing terminal, at the service panel of the DC power plant and to the MESH-BN to at least one point of the SRPP.

The maximum DC voltage drop along each dedicated DC power return conductor shall be designed to be less than 1 V. The calculation shall take into account the maximum load current on the associated supply conductor at maximum or minimum source voltage respectively under normal operating conditions.

NOTE: One concern of this requirement is to avoid electrochemical corrosion by stray currents (see EN 50162 [i.10]).

The DC return path in its entire length shall be capable of carrying over-currents in the case of a fault between a negative power conductor of the secondary supply and the MESH-BN.

The DC return terminal of a power plant powering the telecommunication or ICT system(s) shall be earthed at its DC service panel by a solid connection to the main earthing terminal.

Annex B gives information about necessary agreements if DC return conductors of a single equipment group is not integrated into the merged CBN/MESH-BN.

6.2 DC power distribution of tertiary supplies

The reference potential terminal of tertiary power supplies shall be connected to the MESH-BN.

6.3 AC mains distribution and bonding of the protective conductor

The definitions used in this clause are based on HD 60364-4-41 [1].

The AC power distribution inside a telecommunication or ICT building shall conform to the requirements of the TN-S system. This requires that there shall be no PEN conductor within the building. This is a pre-condition to the requirements in clause 5 of the present document.

See annex C for further details about AC mains distribution and bonding of the protective conductor.

6.4 AC power distribution from tertiary power supply

The neutral point of a tertiary AC power supply shall be derived by bonding the terminal of the star point, or of an outer conductor respectively, to the MESH-BN at the source only. The distribution to the assigned loads shall follow the rules of the TN-S system.

If different configurations resembling an IT system have to be used (e.g. to provide remote feeding or the uninterruptible power supply of a subarrangement), the appropriate safety precautions shall be implemented without degrading the effectiveness of the general requirements in clause 4.

See annex C for further details about AC mains distribution and bonding of the protective conductor.

Annex A (normative): Rationale about CBN co-ordination

In the case of a telecommunication or data centre there are two main subjects needing co-ordination with respect to EMC:

- the building and its related ordinary installations;
- the telecommunication or ICT equipment and its interconnection.

New buildings shall provide adequate preconditions constituting a CBN by:

- a reliable foundation earth electrode system, i.e. a ring conductor immediately beneath the first concrete bed;

NOTE: This electrode system qualifies prior to a ring conductor along the outer perimeter of a building.

- welded joints of building steel or concrete reinforcement rods (see EN 62305 series [i.7]) and a sufficient number of access terminals to these highly conductive elements;
- an enhanced outdoor Lightning Protection System (LPS) co-ordinated with the building structure (see EN 62305 series [i.7]);
- service pipes and air-conditioning ducts interconnected according to the CBN strategy, including potential equalization in excess of safety regulations;
- mains power supply installation as required for the TN-S principle, i.e. without any PEN section downstream from the main earthing terminal and regardless of the principle applied to the mains distribution section upstream. The option in IEC 60364 [i.11], section 546.2.1 permitting for a PEN conductor with a minimum cross sectional area shall not be used.

Telecommunication or ICT equipment which is designed to the present document can be installed and interconnected to the CBN outlined above. The resulting MESH-BN (e.g. see figure 1) should easily conform to EMC requirements.

Some existing buildings of telecommunication or data centres do not provide a CBN sufficient to meet the operational requirements. When a decision is made to extend or replace existing telecommunication or ICT installations in such buildings, the objective should be to move towards a CBN by enhancements.

Besides the fact that such enhancements require consultation on the spot, two subjects can be addressed in general:

- outdoor lightning protection may be installed at first according to EN 62305 series [i.7] including a ring conductor as an essential member of the earthing network. The LPS may be improved with conductive roof layers, closely spaced down conductors or application of metallic facades;
- unacceptable interference from the outdoor power distribution section can be mitigated by a separation transformer dedicated to the building or by an equivalent measure. An indoor installation according to the rules of the IT system or TT system can be upgraded by additional PE conductors and dedicated equipotential bonding conductors, thereby reducing the mesh width. A residual current protection may also be adapted if necessary.

An existing CBN can be augmented by the telecommunication or ICT installation regarding dedicated ring conductors per room and floor, cable ducts/troughs/racks and any other supporting metal work. In contrast to the traditional practice to indulge into a restricted number of conductors with enlarged cross sectional area, it is recommended to aim at a large conductive surface, e.g. by providing bonding at both side bars, at joints within the run of a ladder type cable rack.

As outlined above, co-ordination resulting in an overall CBN/MESH-BN is recommended even in existing telecommunication or data centres. Installation of new equipment with deviation into the Meshed Isolated Bonding Network (MESH-IBN), as defined in Recommendation ITU-T K.27 [i.2] and depicted in figure B-2 of Recommendation ITU-T K.27 [i.2], is considered appropriate in exceptional situations only, such as a deficiency of an adequate lightning protection of the building, or a CBN with an interfering PEN section, or incompatibility with already installed telecommunication or ICT equipment.

Nevertheless, a MESH-IBN type installation according to Recommendation ITU-T K.27 [i.2] needs co-ordination concerning the routing of cables and the bonding of their shields. In addition, maintenance procedures have to be extended to isolation inspection or monitoring.

Annex B (informative): Rationale about the integration of the DC return conductor into the merged CBN/MESH-BN

The integration of the DC return conductor is addressed in clauses 5.4 and 6.1. When existing equipment requires replacement, it is essential that equipment design and installation conforms to a single standard without ambiguity. Agreement to this aim is stated in the Foreword of the present document.

It is recognized that in existing installations groups of equipment may be operated with "isolated" DC return conductors, whereby "isolated" denotes the application of the DC-I version addressed in Recommendation ITU-T K.27 [i.2].

If the design of such equipment allows for operation with integrated DC return conductors, the existing installation should be adapted to the present document.

If the operation of such equipment requires the existing installation to be unchanged, precautions should be taken to facilitate appropriate inter system signal exchange and compliance to other EMC requirements.

Selection of such precautions should take into account:

- inter system signal exchange by isolated and symmetrically operated circuitry;
- routing of cables with shields via a common bonding point, located as near as possible to the main earthing terminal, e.g. the main distribution frame, if transmission parameters allow for an additional length of the transmission path;
- appropriate conductor arrangements in parallel to the inter system cabling route with minimized length dictated by transmission requirements, i.e. provision of shielding and potential equalization simultaneously;
- upgrading of the current conducting capability of the drain path for short circuit currents, i.e. provision of dedicated conductors without the steady state DC return function.

If the outlined adaptation of the existing installation is impossible due to an additional insufficiency of the CBN, installation of a new system block may follow the rules of the MESH-IBN (see annex A).

An example, of a CBN/MESH-BN configuration, with isolated return conductor connected to the CBN at a single point, is given in figure B.1.

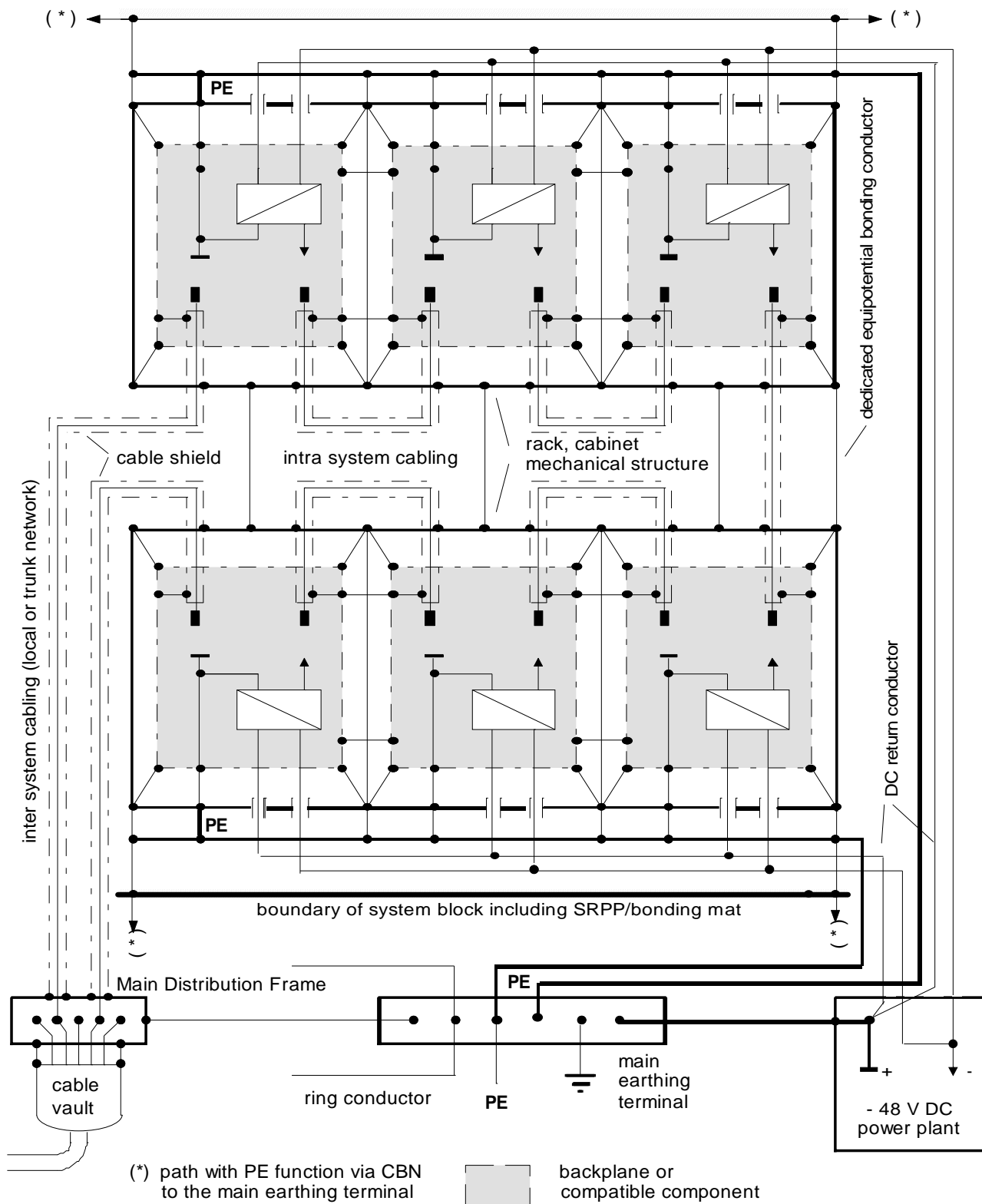

Figure B.1: Example of a CBN/MESH-BN configuration with isolated DC return conductor connected to the CBN at a single point

Annex C (normative): AC mains distribution and bonding of the protective conductor

Depending on the outdoor mains distribution network serving a telecommunication or ICT building, one of the following requirements shall apply:

- a) service by a TN-S section of the outdoor distribution network:
solely the protective conductor (PE) shall be connected to the main earthing terminal (see figure C.1, structure 1 and figure C.2, mode 1);
- b) service by a TN-C section of the outdoor distribution network:
 - 1) the PEN conductor shall be connected to the main earthing terminal only;
 - 2) from the main earthing terminal to and within the consumer locations inside the building the Neutral conductor (N) shall be treated as a live conductor;
 - 3) a dedicated PE shall be provided (see figure C.1, structure 2 and figure C.2, mode 2);
- c) service by a TT section of the outdoor distribution network:
 - 1) the PE shall be derived via the main earthing terminal from the earthing network (see figure C.1, structure 3 and figure C.2, mode 3);
 - 2) the dimensioning of the PE shall follow the rules of the TN-S system;
- d) service by an IT section of the outdoor distribution network:
indoor installation related to earthing and bonding shall follow the instructions set up for the service by a TT section of the outdoor distribution network.

NOTE: Public service by an IT section of the outdoor distribution network is known as a special national condition. As the IT system is liable to deteriorate into a TT system, reference is given in the present document to that related section. For information regarding unacceptable interference by an IT system, see annex A.

	Neutral conductor (N); mid-point conductor (M)
	Protective conductor (PE)
	Combined protective and neutral conductor (PEN)

Figure C.1a: Neutral and protective conductor symbol



NOTE Additional earthing of the PE in the installation may be provided.

NOTE: This figure is extracted from IEC 60364-1 [i.11] ed. 5.0, "Copyright© 2005 IEC Geneva, Switzerland. www.iec.ch/".

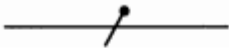
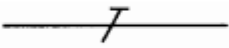
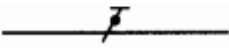
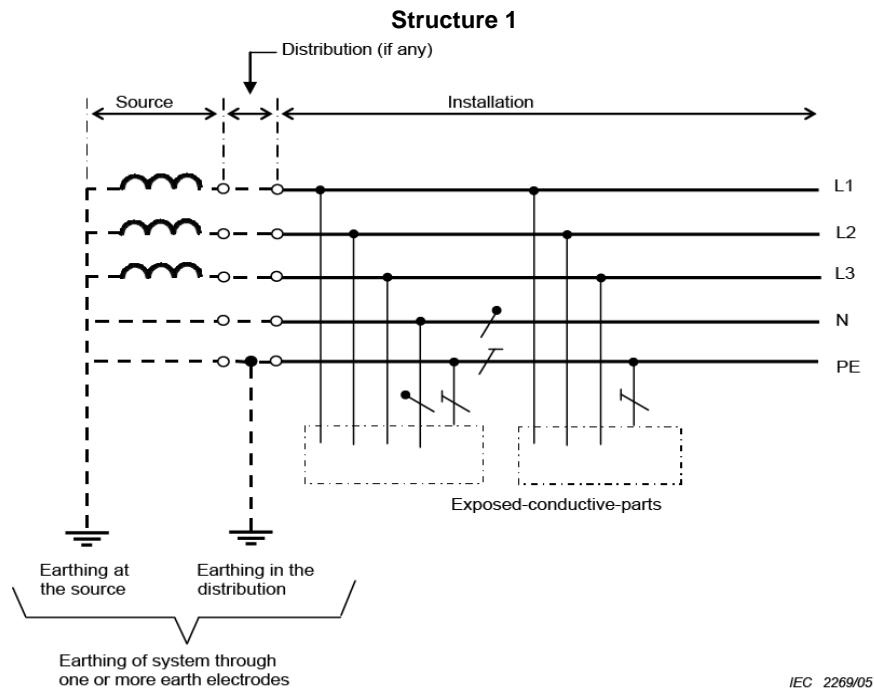
- origin of PE at the main earthing terminal of the power source;
- PE is intentionally earthed intermediately in the distribution and at each main earthing terminal;
- N and PE are separated throughout the distribution, the indoor installation and within each equipment.

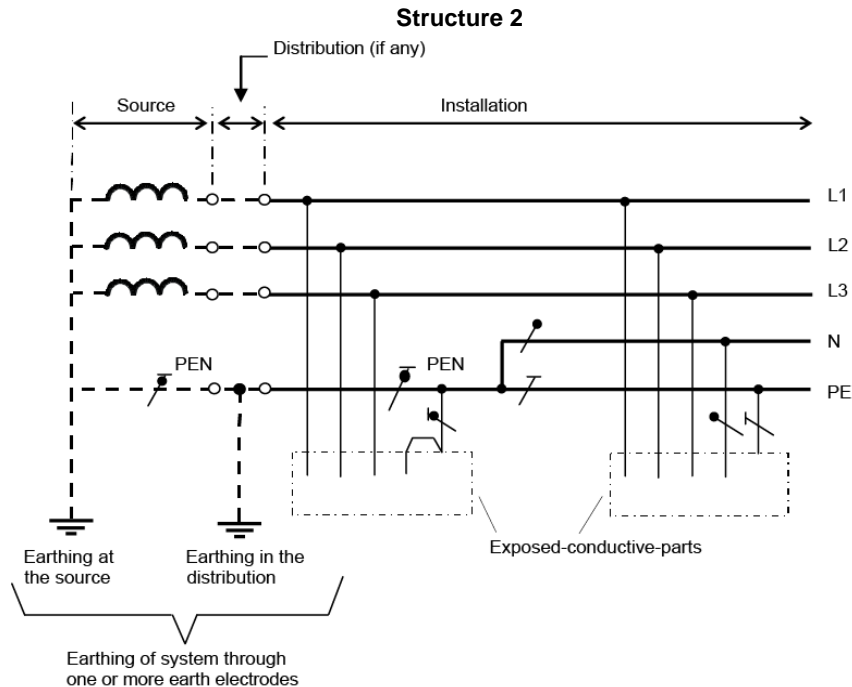

Neutral and protective conductor functions combined in a single conductor in a part of the system.

NOTE Additional earthing of the PE in the installation may be provided.

NOTE: This figure is extracted from IEC 60364-1 [i.11] ed. 5.0, "Copyright© 2005 IEC Geneva, Switzerland. www.iec.ch/".

- origin of PEN at the main earthing terminal of the power source;
- PEN is intentionally earthed intermediately in the distribution and at each main earthing terminal;

- origin of N and PE at the main earthing terminal of the indoor installation;
- N and PE are separated throughout the indoor installation and within each equipment.

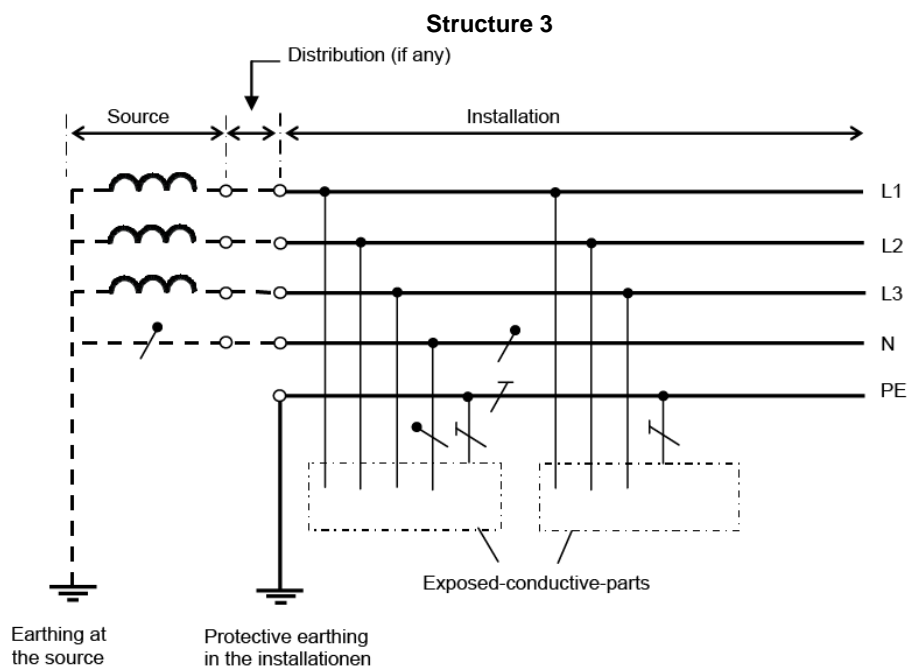

IEC 2278/05

NOTE Additional earthing of the PE in the installation may be provided.

NOTE: This figure is extracted from IEC 60364-1 [i.11] ed. 5.0, "Copyright© 2005 IEC Geneva, Switzerland. www.iec.ch/".

- origin of PE at the local main earthing terminal of the indoor installation;
- N and PE are separated throughout the indoor installation and within each equipment.

**Figure C.1: Conventional mains supply systems
(based on IEC Publication 60364-1 [i.11], section 312.2)**

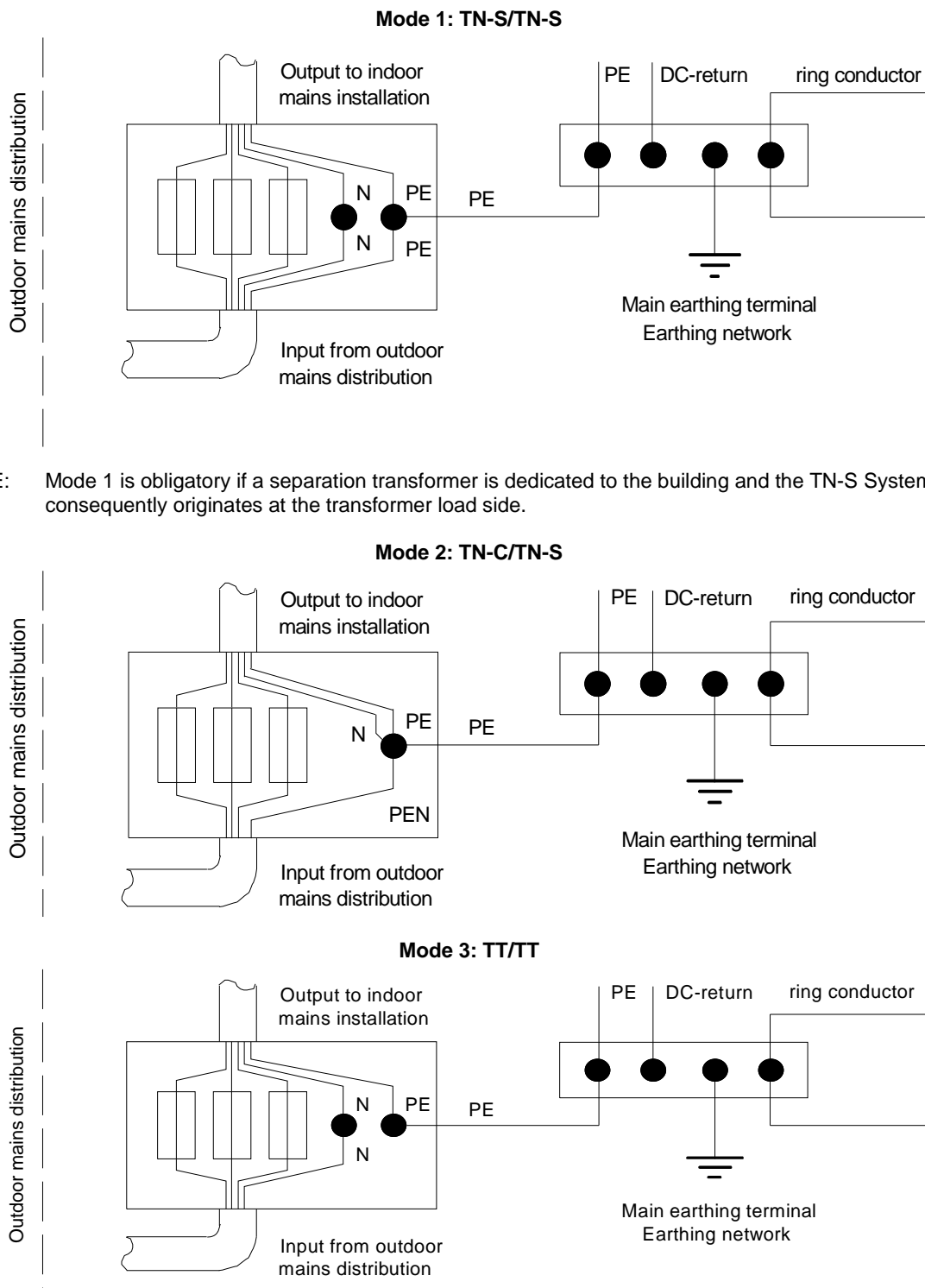

NOTE: Mode 1 is obligatory if a separation transformer is dedicated to the building and the TN-S System consequently originates at the transformer load side.

Figure C.2: Arrangements for the transition from the outdoor mains distribution network to the indoor mains installation

Annex D (informative): Bibliography

ETSI ETS 300 132-1: "Equipment Engineering (EE); Power supply interface at the input to telecommunications equipment interface; Part 1: Interface operated by Alternating Current (AC)".

ETSI EG 201 147: "Equipment Engineering (EE); Interworking between Direct Current/Isolated (d.c.-I) and Direct Current/Common (d.c.-C) electrical power systems".

ETSI EG 201 212: "Electrical safety: Classification of interfaces for equipment to be connected to telecommunication networks".

History

Document history		
Edition 1	January 1995	Publication as ETSI ETS 300 253
V2.1.1	April 2002	Publication
V2.1.11	January 2015	EN Approval Procedure AP 20150526: 2015-01-26 to 2015-05-26