



安森美半导体
ON Semiconductor[®]

交错式功率因数校正

Interleaved PFC

议程 Agenda

□ 简介 Introduction:

- 交错式PFC基础知识 Basics of interleaving
- 主要优势 Main benefits

□ NCP1631: 新颖的交错式PFC控制器 NCP1631: a novel controller for interleaved PFC

- 异相管理 Out-of-phase management
- NCP1631支持使用较小电感 The NCP1631 allows the use of smaller inductors
- 主要功能 Main functions

□ 实验结果及性能 Experimental results and performance

- 一般波形 General waveforms
- 能效 Efficiency

□ 总结 Summary

交错式功率因数校正(PFC) Interleaved PFC

- 以两个功率为 $(P_{in(avg)}/2)$ 的较小PFC段替代单个较大PFC段 Two small PFC stages delivering $(P_{in(avg)}/2)$ in lieu of a single big one

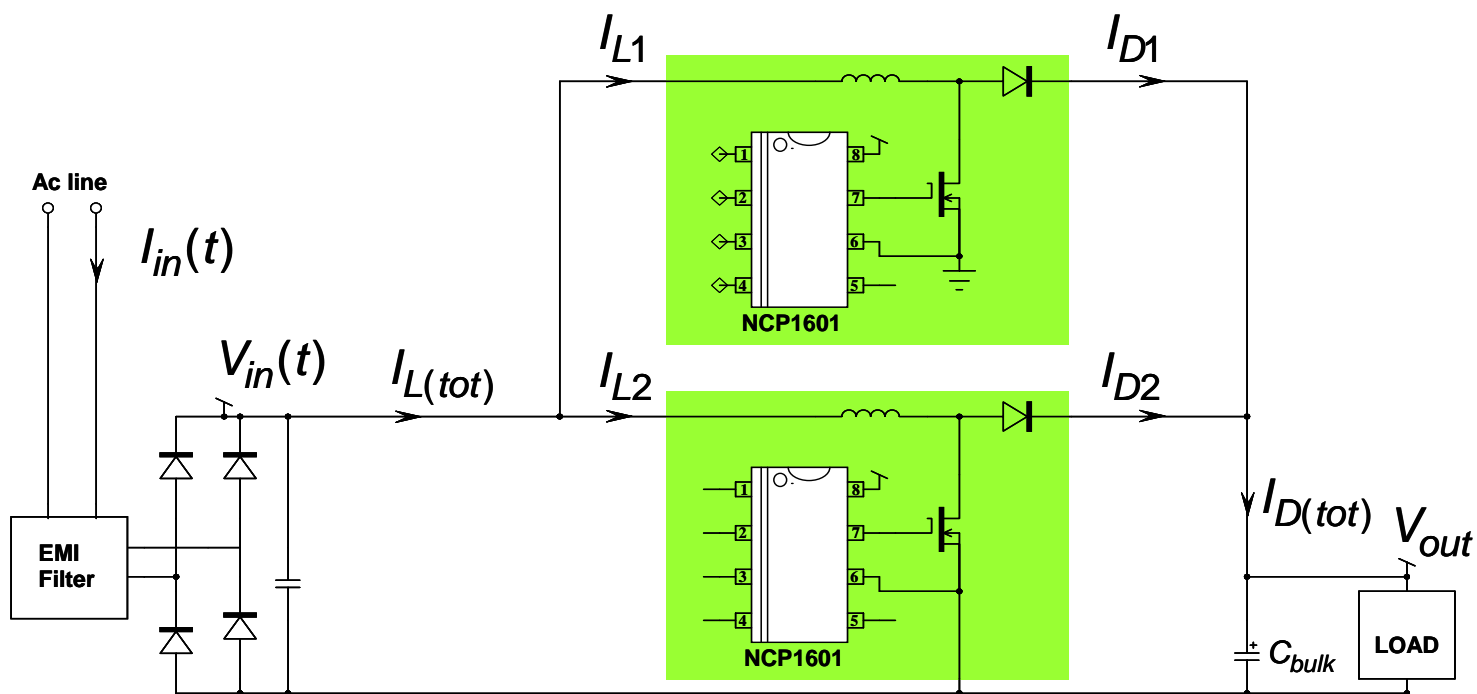

- 如果两个相位异相，因此产生的电流 $(I_{L(tot)})$ 和 $(I_{D(tot)})$ 纹波大幅减小 If the two phases are out-of-phase, the resulting currents $(I_{L(tot)})$ and $(I_{D(tot)})$ exhibit a dramatically reduced ripple.

交错式PFC优势 Interleaved Benefits

□ 所用元器件更多，但 More components but:

- 150 W PFC比300 W PFC更易于设计 A 150-W PFC is easier to design than a 300-W one
- 模块化途径 Modular approach
- 散热更好 Better heating distribution
- 扩展临界导电模式(CrM)范围 Extended range for Critical Conduction Mode (CrM)
- 元件尺寸更小，支持纤薄设计 Smaller components
(帮助符合严格的外形因数需求，如平板电视 help meet strict form factor needs – e.g., flat panels)
- 两个不连续导电模式(DCM) PFC看上去象一个连续导电模式(CCM) PFC转换器 Two DCM PFCs look like a CCM PFC converter...
 - 简化电磁干扰(EMI)滤波，减小输出均方根(rms)电流 Eases EMI filtering and reduces the output rms current

输入及输出电流 Input and Output Current

什么是 $I_{L(tot)}$ 总输入电流纹波？

What is the ripple of the $I_{L(tot)}$ total input current?

什么是 $I_{D(tot)}$ 总输出电流纹波？

What is the ripple of the $I_{D(tot)}$ total output current?

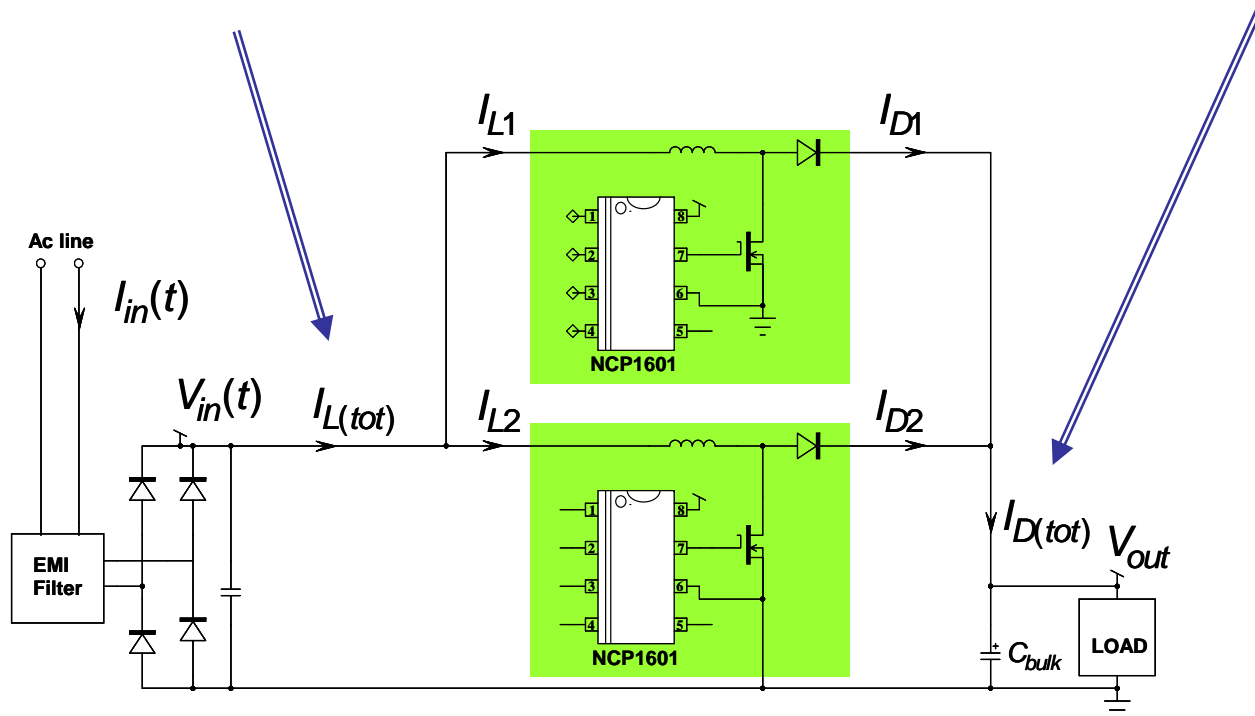

低交流线路时的输入电流纹波

Input Current Ripple at Low Line

- 当输入电压保持低于输出电压的一半时，输入电流看上去象CCM滞后PFC的输入电流 When V_{in} remains lower than $V_{out}/2$, the input current looks like that of a CCM, hysteretic PFC
- $(I_{L(tot)})$ 在两个接近的正弦迹线间摆动 $(I_{L(tot)})$ swings between two nearly sinusoidal envelops

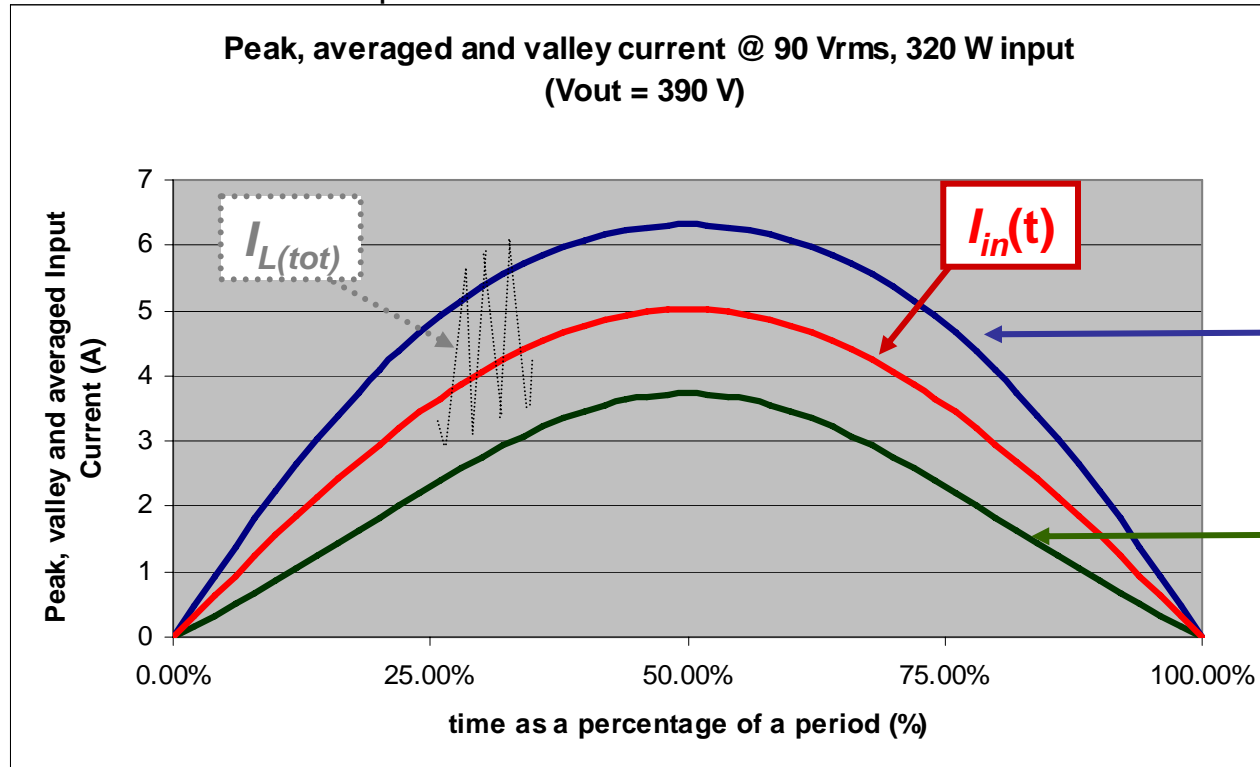

高交流线路时的输入电流纹波

Input Current Ripple at High Line

□ 输入电压超过输出电压的一半时，谷底电流保持恒定！ When V_{in} exceeds $(V_{out}/2)$, the valley current is constant!

□ 此电流等于 It equates $\left(\frac{V_{out}}{2 \cdot R_{in}}\right)$ 其中， R_{in} 是PFC输入阻抗 where R_{in} is the PFC input impedance

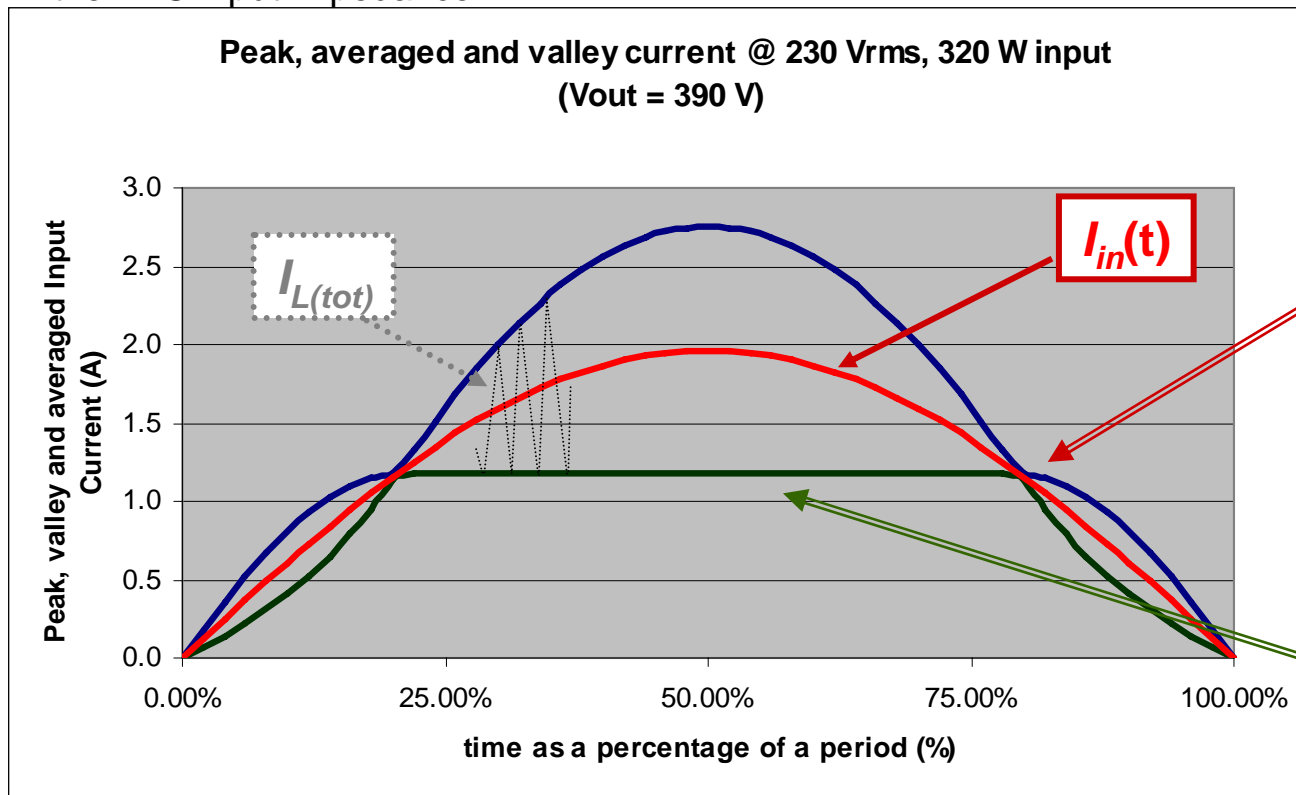

$V_{in} = V_{out}/2$ 时
无纹波
No ripple when
 $V_{in} = V_{out}/2$

$$\frac{P_{in(avg)} \cdot V_{out}}{2 \cdot V_{in(rms)}^2} = \frac{V_{out}}{2 \cdot R_{in}}$$



交流线路输入电流 Line Input Current

- 对于每个支路而言，正弦波的某处波形有如： For each branch, somewhere within the sinusoid:

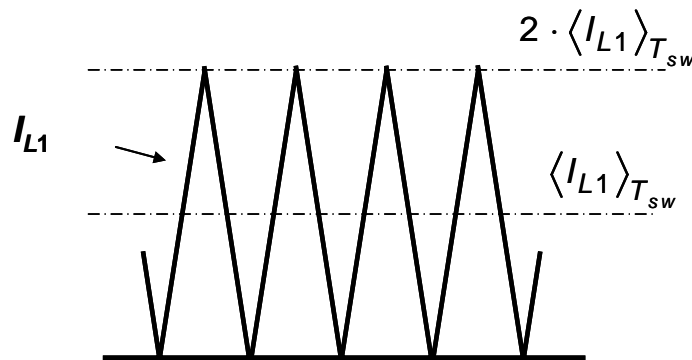

- 两个平均正弦相位电流之和得到总线电流： The sum of the two averaged, sinusoidal phases currents gives the total line current:

$$I_{in} = \left\langle I_{L(tot)} \right\rangle_{T_{sw}} = \left\langle I_{L1} \right\rangle_{T_{sw}} + \left\langle I_{L2} \right\rangle_{T_{sw}}$$

- 假定有极佳的电流平衡： Assuming a perfect current balancing:

$$2 \cdot \left\langle I_{L1} \right\rangle_{T_{sw}} = 2 \cdot \left\langle I_{L2} \right\rangle_{T_{sw}} = I_{in}$$

- 每个支路的峰值电流就是 $I_{in}(t)$ ： The peak current in each branch is $I_{in}(t)$

充电电流的交流分量

Ac Component of the Refueling Current

- 充电电流(输出二极管电流)取决于工作模式 The refueling current (output diode(s) current) depends on the mode:

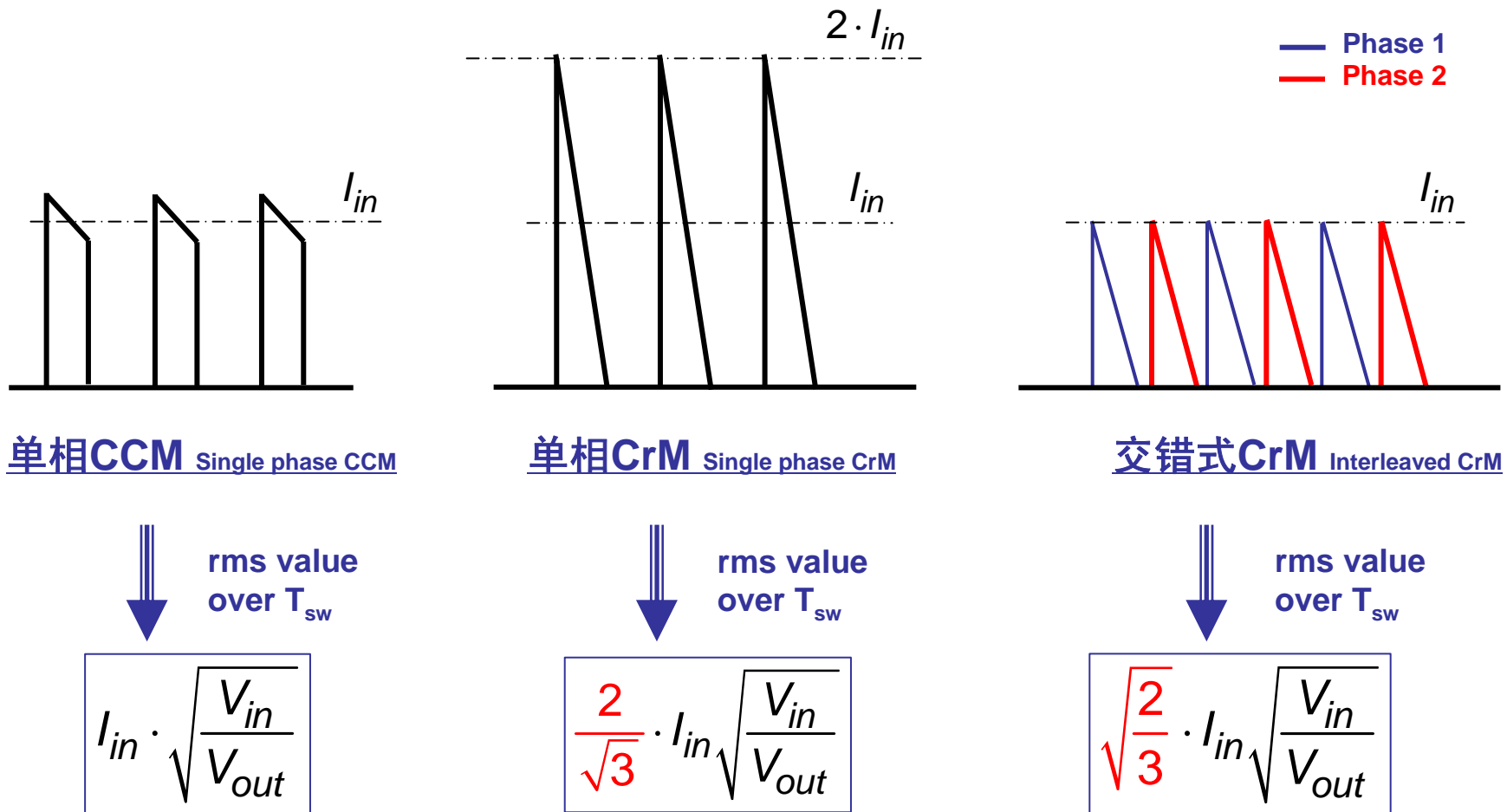

大电容均方根电流降低

A Reduced Rms Current in the Bulk Capacitor

□ 正弦电流积分可得到(电阻型负载): Integration over the sinusoid leads to (resistive load):

	单相CCM PFC Single phase CCM PFC	单相CrM或FCCrM* PFC Single phase CrM or FCCrM* PFC	交错式CrM或FCCrM* PFC Interleaved CrM or FCCrM* PFC
二极管均方根 电流 Diode(s) rms current ($I_{D(rms)}$)	$\sqrt{\frac{8\sqrt{2} \cdot \left(\frac{P_{out}}{\eta}\right)^2}{3\pi \cdot V_{in(rms)} \cdot V_{out}}}$	$\frac{2}{\sqrt{3}} \cdot \sqrt{\frac{8\sqrt{2} \cdot \left(\frac{P_{out}}{\eta}\right)^2}{3\pi \cdot V_{in(rms)} \cdot V_{out}}}$	$\sqrt{\frac{2}{3}} \cdot \sqrt{\frac{8\sqrt{2} \cdot \left(\frac{P_{out}}{\eta}\right)^2}{3\pi \cdot V_{in(rms)} \cdot V_{out}}}$
Capacitor rms current ($I_{C(rms)}$)	$\sqrt{\frac{8\sqrt{2} \cdot \left(\frac{P_{out}}{\eta}\right)^2}{3\pi \cdot V_{in(rms)} \cdot V_{out}} - \left(\frac{P_{out}}{V_{out}}\right)^2}$	$\sqrt{\frac{32\sqrt{2} \cdot \left(\frac{P_{out}}{\eta}\right)^2}{9\pi \cdot V_{in(rms)} \cdot V_{out}} - \left(\frac{P_{out}}{V_{out}}\right)^2}$	$\sqrt{\frac{16\sqrt{2} \cdot \left(\frac{P_{out}}{\eta}\right)^2}{9\pi \cdot V_{in(rms)} \cdot V_{out}} - \left(\frac{P_{out}}{V_{out}}\right)^2}$
300-W, $V_{out}=390$ V $V_{in(rms)}=90$ V	$I_{D(rms)} = 1.9$ A $I_{C(rms)} = 1.7$ A	$I_{D(rms)} = 2.2$ A $I_{C(rms)} = 2.1$ A	$I_{D(tot)(rms)} = 1.5$ A $I_{C(rms)} = 1.3$ A

□ 交错式PFC大幅降低均方根电流 Interleaving dramatically reduces the rms currents

→ 降低损耗, 减少发热量, 提升可靠性 reduced losses, lower heating, increased reliability

* 频率钳位CrM Frequency Clamped CrM

交错式PFC小结 Finally...

- 交错式PFC结合了 Interleaved PFC combines:
 - 临界导电模式(CrM)工作的优势 The advantages of CrM operations
 - 不需要低反向恢复时间(t_{rr})二极管 No need for low t_{rr} diode
 - 高能效 High efficiency
 - 降低输入电流纹波，将大电容中均方根电流减至最小 A reduced input current ripple and a minimized rms current in the bulk capacitor
 - 散热更好 A better distribution of heating
- 元器件数量更多，但尺寸“较小” More components but “small” ones
- 精心调配，适合纤薄外形因数应用，如笔记本适配器和液晶电视
Well adapted to slim form factor applications such as notebook adapters and LCD TVs
- 更多信息参见安森美半导体应用笔记AND8355 Refer to application note AND8355 for more details

议程 Agenda

□ 简介 Introduction:

- 交错式PFC基础知识 Basics of interleaving
- 主要优势 Main benefits

□ NCP1631: 新颖的交错式PFC控制器 NCP1631: a novel controller for interleaved PFC

- 异相管理 Out-of-phase management
- NCP1631支持使用较小电感 The NCP1631 allows the use of smaller inductors
- 主要功能 Main functions

□ 实验结果及性能 Experimental results and performance

- 一般波形 General waveforms
- 能效 Efficiency

□ 总结 Summary

NCP1631概览 NCP1631 Overview

- ❑ 交错式2相PFC控制器 Interleaved, 2-phase PFC controller
- ❑ 频率钳位临界导电模式(FCCrM)优化完整负载范围内的能效
Frequency Clamped Critical conduction Mode (FCCrM) to optimize the efficiency over the load range.
- ❑ 包括启动、过流保护(OCP)或瞬态序列在内的所有条件下提供稳固的异相工作 Substantial out-of-phase operation in all conditions including start-up, OCP or transient sequences.
- ❑ 具备前馈，改善环路补偿 Feedforward for improved loop compensation
- ❑ 简化下行转换器设计 Eased design of the downstream converter:
 - 提供“pfcOK”信号，含动态响应增强器及待机管理功能 pfcOK, dynamic response enhancer, standby management
- ❑ 高保护等级 High protection level:
 - 输入欠压保护，精确的1引脚限流，浪涌电流检测，单独引脚用于(可编程)过压保护(OVP)等 Brown-out protection, accurate 1-pin current limitation, in-rush currents detection, separate pin for (programmable) OVP...

NCP1631概览

NCP1631 Overview

□ 交错式2相PFC控制器 Interleaved, 2-phase PFC controller

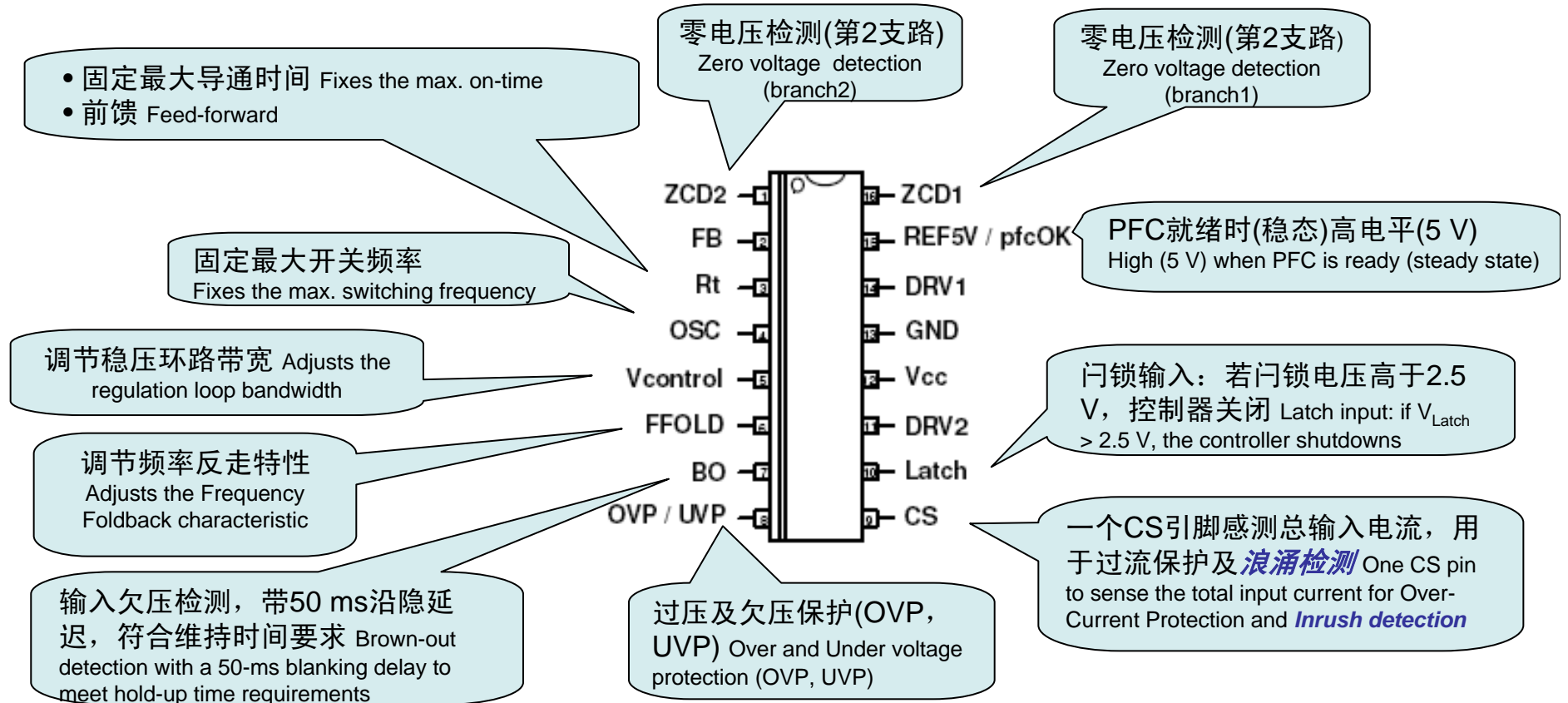

NCP1631 典型应用

NCP1631 Typical Application

提示下行转换器PFC已经就绪 Indicates the downstream converter that the PFC is ready

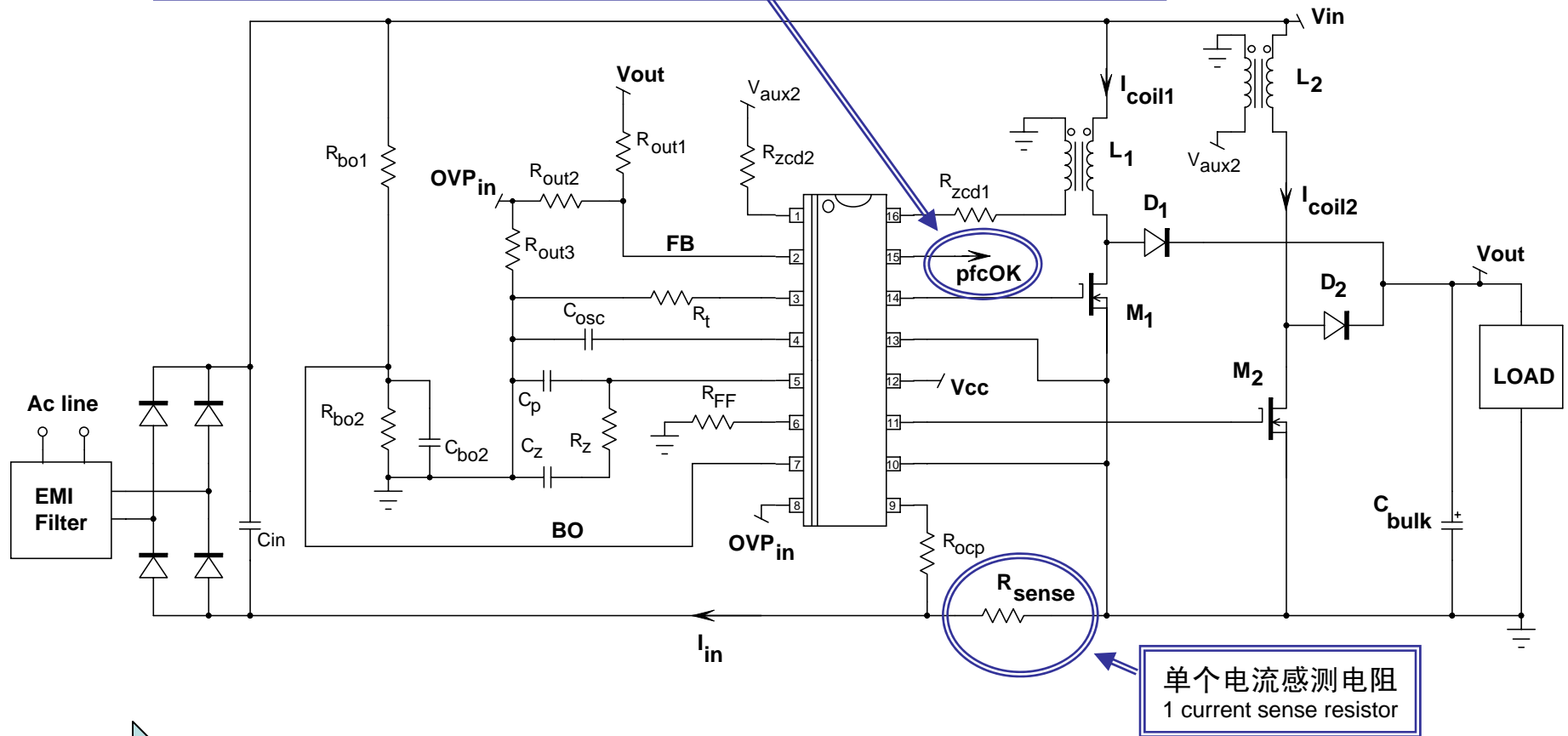

单个电流感测电阻
1 current sense resistor

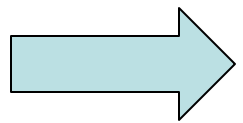

完全内部实现相位同步 Synchronization of phases is completely internal



交错式PFC：主/从方案

Interleaving: Master / Slave Approach...

- ❑ 主支路自由工作 The master branch operates freely
- ❑ 从支路以 180° 相移跟随主支路工作 The slave follows with a 180° phase shift
- ❑ 主要挑战：维持CrM工作(无CCM，无死区时间) Main challenge: maintaining the CrM operation (no CCM, no dead-time)

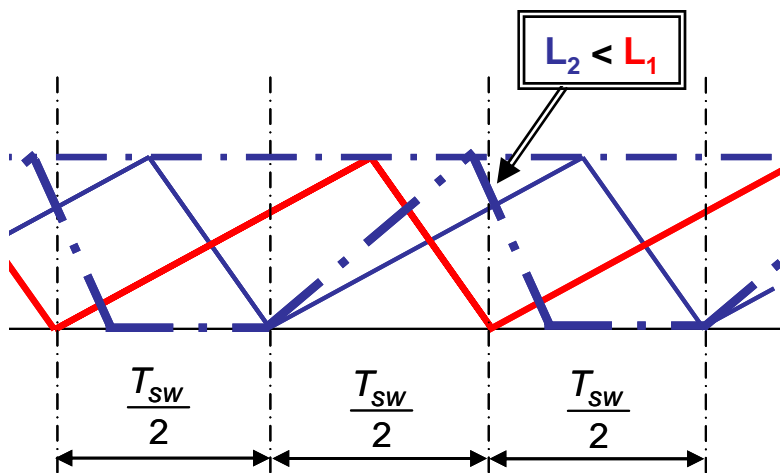

电流模式：电感不平衡
Current mode: inductor unbalance

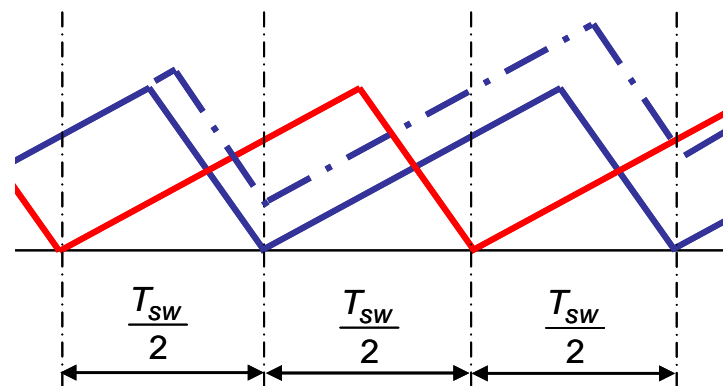

电压模式：导通时间转换
Voltage mode: on-time shift

交错式PFC：交互作用相位方案

Interleaving: Interactive-Phase Approach...

- ❑ 每个相位都恰当地工作在CrM Each phase properly operates in CrM
- ❑ 两个相位交互作用，设定 180° 的相移 The two branches interact to set the 180° phase shift
- ❑ 主要挑战：保持恰当的相移 Main challenge: to keep the proper phase shift

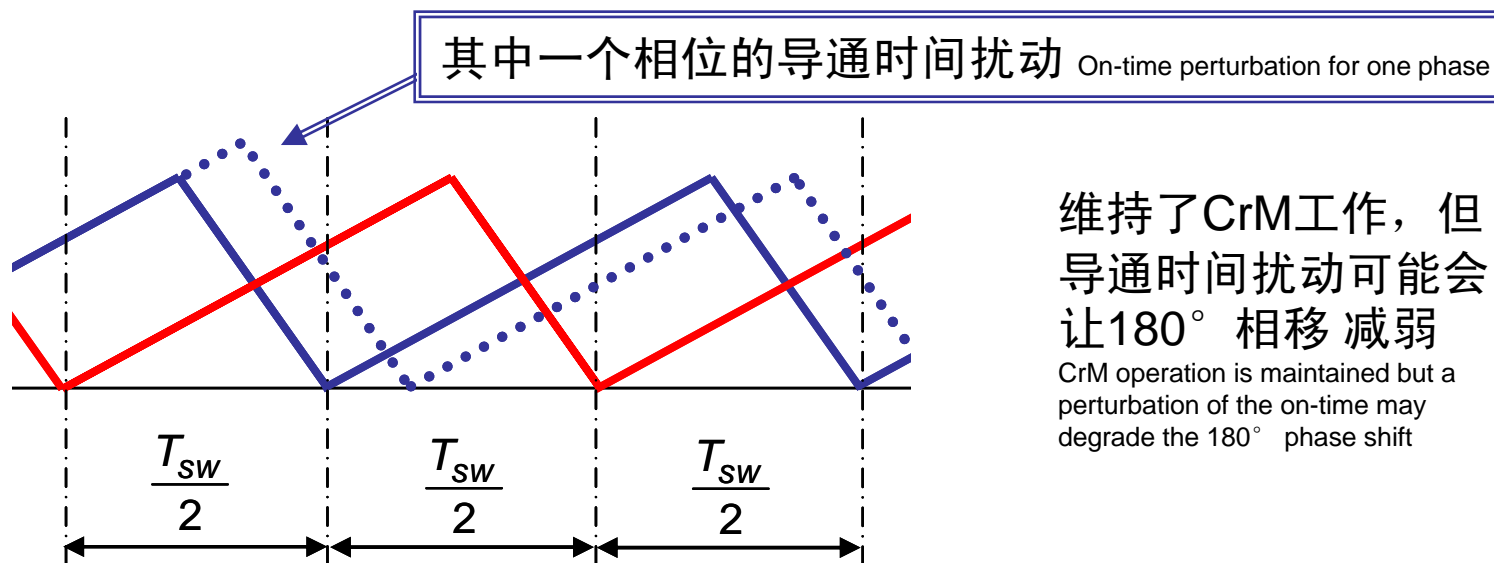

- ❑ 我们选择的是这种方案 We selected this approach

交错式管理 Interleaving Management

- ❑ 振荡器管理异相工作 The oscillator manages the out-of-phase operation
- ❑ 振荡器充当**交错式时钟产生器** It acts as the *interleaved clocks generator*

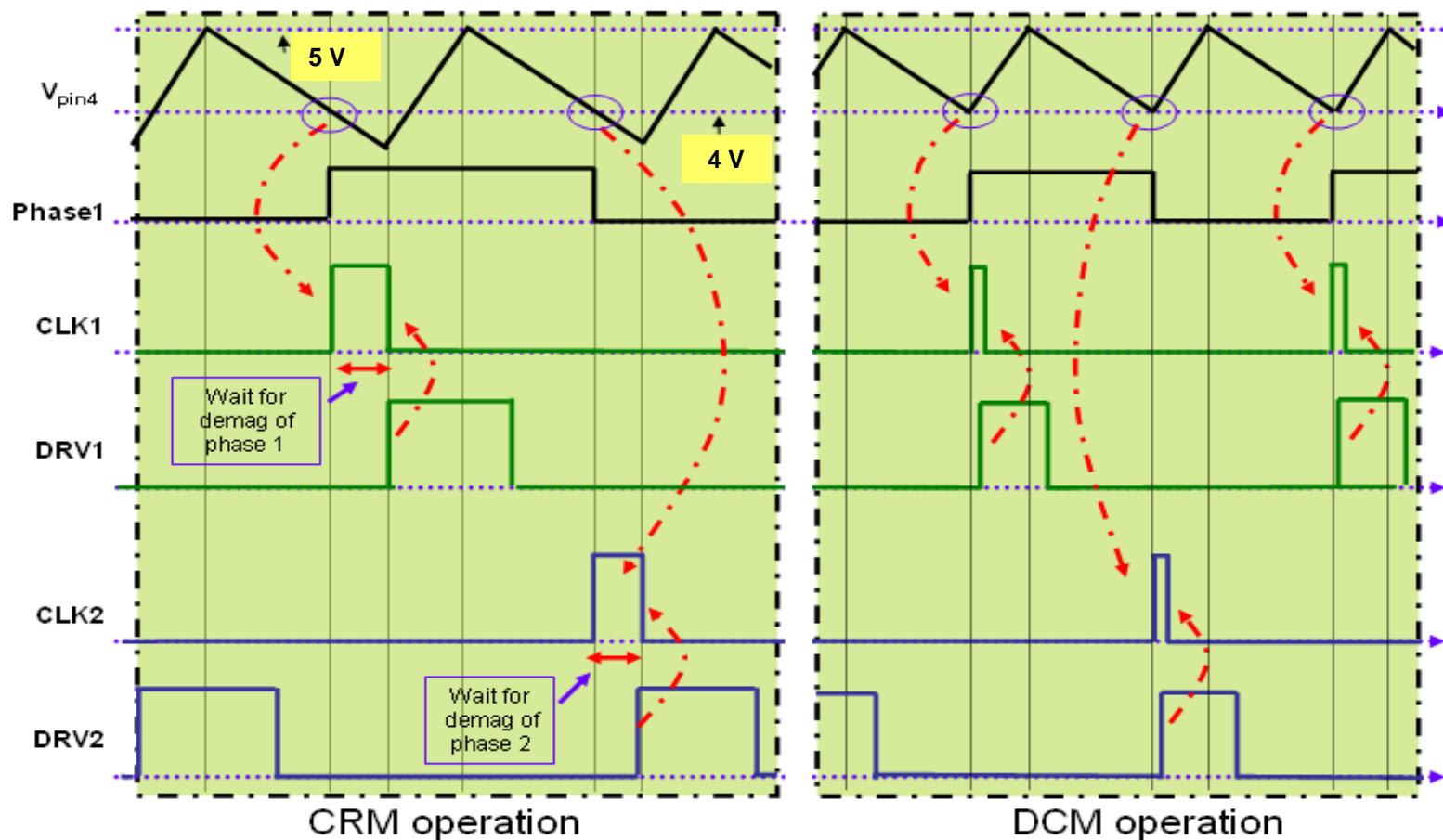

2个支路间的电流平衡

Current Balancing between the 2 Branches

- ❑ NCP1631采用电压模式工作 The NCP1631 operates in voltage mode
- ❑ 两个支路的导通时间相同，故开关周期也相同 Same on-time and hence switching period in the two branches
- ❑ 电感不平衡 An imbalance in the inductors:
 - 不影响开关周期 Does not affect the switching period
 - 仅导致每个支路转换的功率数量有差别 “Only” causes a difference in the power amount conveyed by each branch

$$\frac{I_{in(1)}}{I_{in(2)}} = \frac{L_2}{L_1}$$

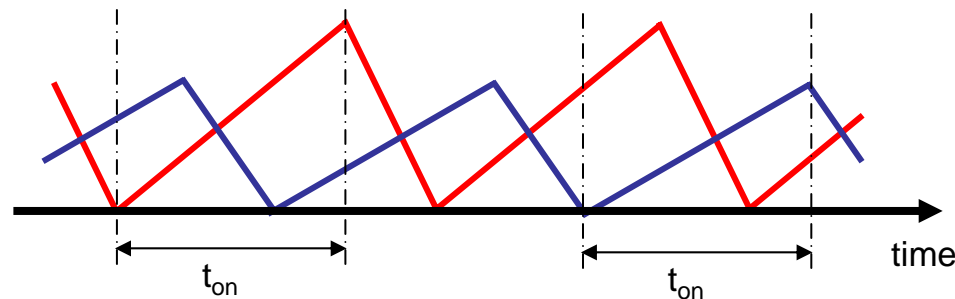

$$L_1 > L_2$$

— Phase 1
— Phase 2

- ❑ 两个支路仍保持同步 The two branches remains synchronized
- ❑ 保持临界导电模式(CrM)工作(或FCCrM) CrM operation is kept (or FCCrM)
- ❑ 180° 相移没有改变 No alteration of the 180-degree phase shift

人为制造不平衡 Artificial Unbalancing

- 在测试中，采用300 μH 的线圈来替代支路1中的150 μH 电感
In this test, the 150- μH inductor of branch 1 is replaced by a 300- μH coil !!!!
- 因此，支路2消耗更多电流，且支路2中的MOSFET(通常)更热
Hence, more current is drawn by branch2 and MOSFET of branch2 is (normally) hotter
- 后面的图中显示PFC段在这些极端条件及满载下的工作特性
The following plots show how the PFC stage behaves in these extreme conditions and full load

在恶劣状态下仍然工作 Still Operates in a Robust Manner...

120 Vrms, 0.8 A
(PF = 0.997, THD = 6%)

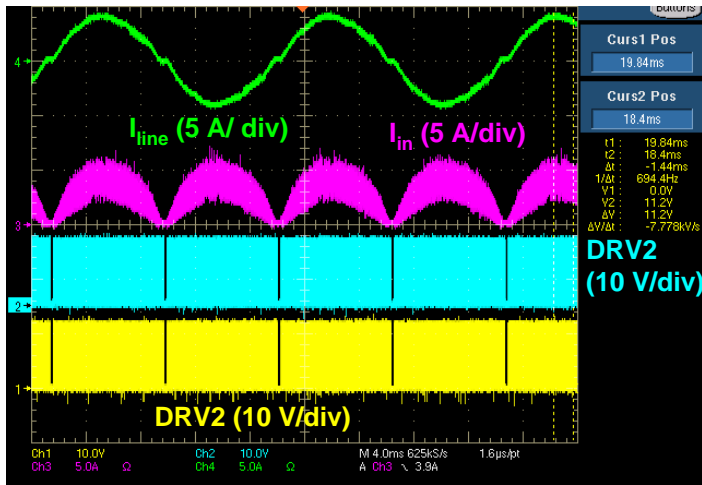

230 Vrms, 0.8 A
(PF = 0.980, THD = 11%)

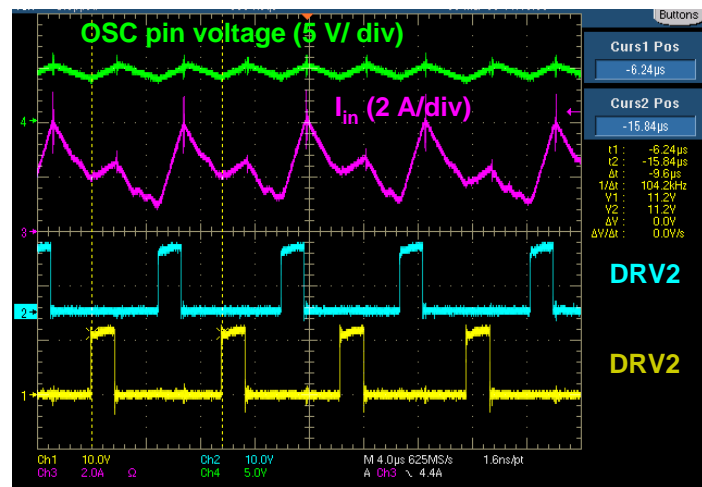
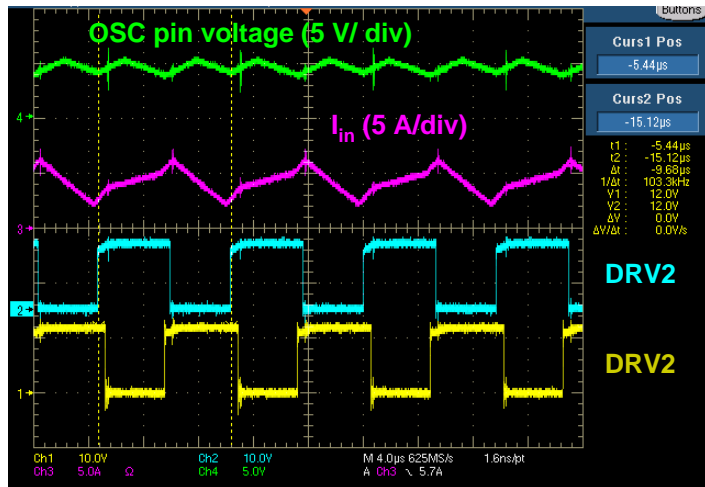
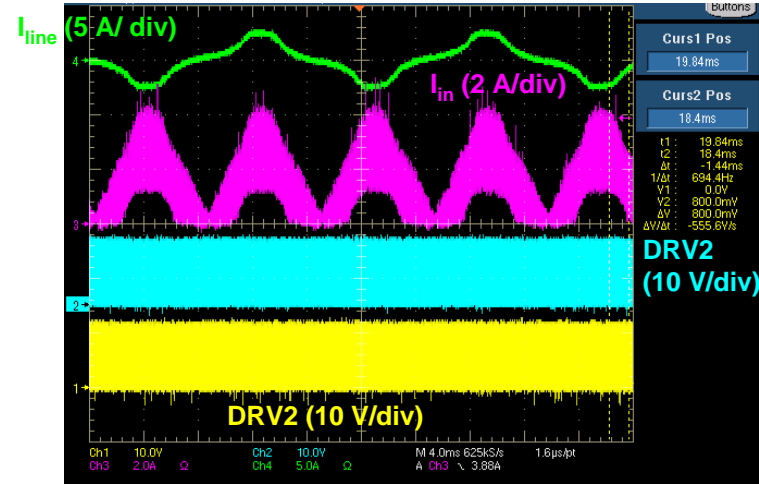

CrM开关频率变化

Switching Frequency Variations in CrM

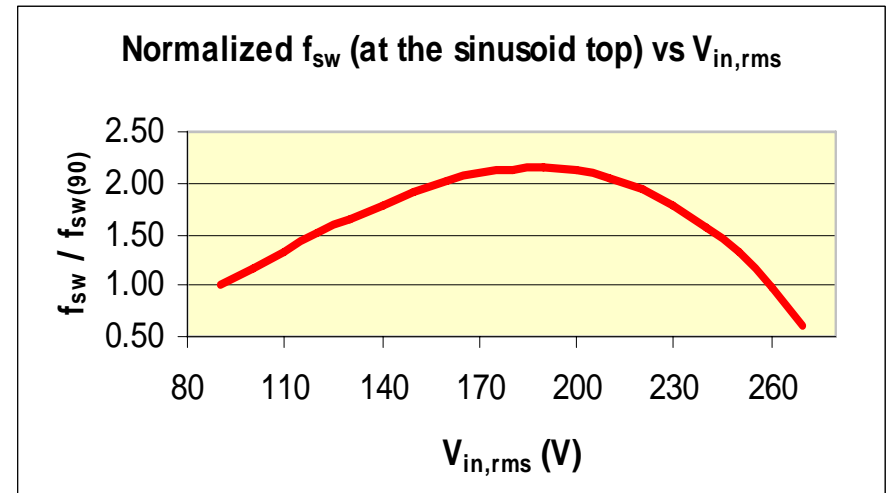
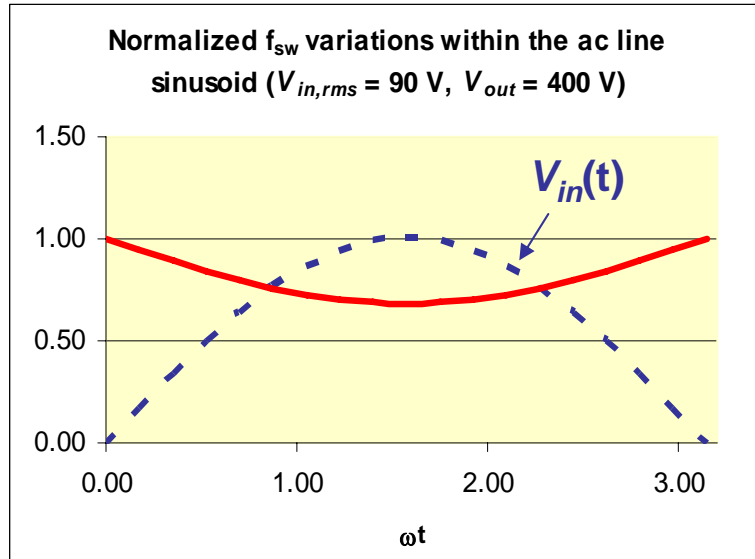

开关频率变大 f_{sw} becomes large

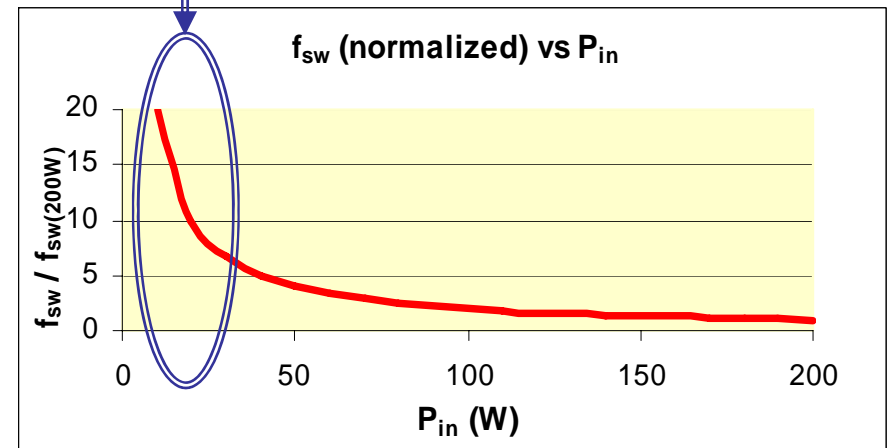

□ 开关频率随着输入功率、交流线路幅度的不同而以正弦波变化 The switching frequency varies versus the input power, the ac line amplitude and within the sinusoid

□ f_{sw} 在轻载时变高，导致较大开关损耗

f_{sw} becomes high at light load, leading to large switching losses

□ 应当限制 f_{sw} f_{sw} should be limited

限制开关频率以优化能效

Limiting f_{sw} to Optimize the Efficiency

- 在正弦波顶部 At the top of the sinusoid:

$$f_{sw} = \frac{(V_{in,pk})^2}{4 \cdot L \cdot P_{in,avg}} \left(1 - \frac{V_{in,pk}}{V_{out}} \right)$$

- CrM工作要求大电感来限制轻载时的开关损耗 CrM operation requires large inductors to limit the switching losses at light load
- 我们是否能够不使用大尺寸电感而钳位开关频率？ Can't we clamp f_{sw} not to over-dimension L?
- 频率钳位临界导电模式 Frequency Clamped Critical conduction Mode (FCCrM)

频率钳位临界导电模式(FCCrM)

Frequency Clamped Critical Conduction Mode

- 轻载时，电流周期短 At light load, the current cycle is short
- 电流周期短于振荡器周期时，振荡器周期过去后才有新的电流周期→死区时间(DCM) When shorter than the oscillator period, no new cycle until the oscillator period is elapsed → dead-times (DCM)
- 增加导通时间以补偿死区时间→功率因数(PF)没有降低(安森美半导体专有技术) On-times are increased to compensate the dead-times → no PF degradation (ON proprietary)

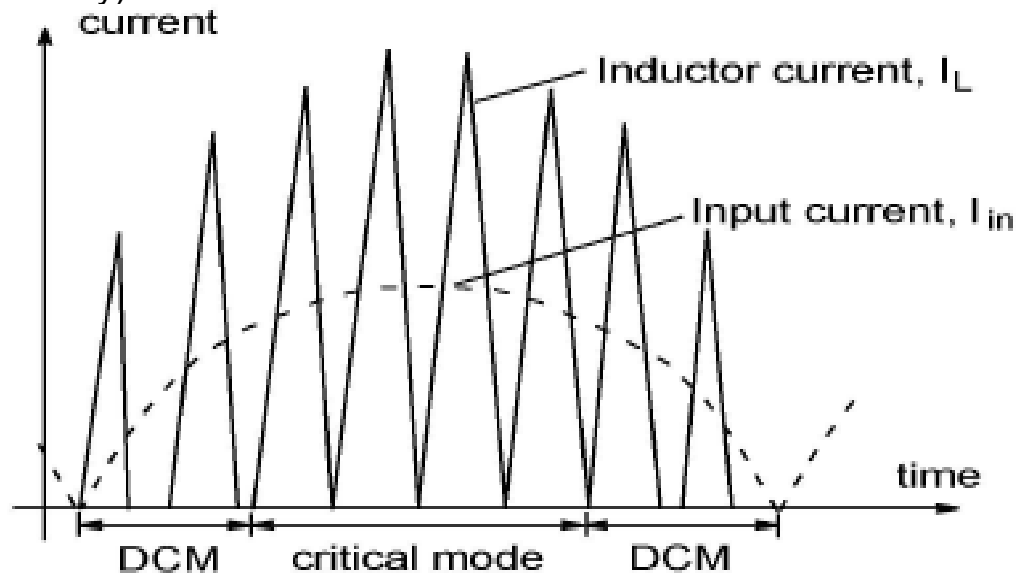

NCP1631工作-频率钳位临界导电模式(FCCrM)

NCP1631 Operation - FCCrM

- ❑ 在FCCrM，开关频率钳位 In FCCrM, the switching frequency is clamped:
 - 轻载时及接近线路过零点时频率固定 Fixed frequency in light load mode and near the line zero crossing
 - 满载时实现临界导电模式(CrM) Critical conduction mode (CrM) achieved at full load.
- ❑ FCCrM优化完整负载范围内的能效 FCCrM optimizes the efficiency over the load range.
- ❑ FCCrM缩小要电磁干扰(EMI)滤波的频率范围 FCCrM reduces the range of frequencies to be filtered (EMI)
- ❑ **FCCrM支持使用小尺寸电感** FCCrM allows the use of smaller inductors
 - 不需大电感以限制频率范围！ No need for large inductances to limit the frequency range!
 - 如150 μH 电感(PQ2620)适合宽主电源范围的300 W应用 E.g., 150 μH (PQ2620) for a wide mains 300-W application
- ❑ 频率反走功率降低轻载时的钳位频率，进一步改善能效 Frequency Foldback reduces the clamp frequency at light load to further improve the efficiency

NCP1631 频率反走 NCP1631 Frequency Foldback

- ❑ 输入功率减小到低于预设功率电平(P_{LL})时, 钳位频率 **线性降低** The clamp frequency **linearly** decays when P_{in} goes below a preset level (P_{LL})

- ❑ P_{LL} 由引脚6电阻设定 P_{LL} is programmed by the pin6 resistor

$$\frac{(P_{in})_{FF}}{(P_{in})_{HL}} = \frac{R_{pin6} \cdot 105 \mu A}{1.66} \cong \frac{R_{pin6}}{15810}$$

$(P_{in})_{HL}$ 是PFC段能提供的最大功率 ($P_{in})_{HL}$ is the max. power deliverable by the PFC stage

示例: 40%负载及130 kHz额定频率时的频率反走

Example: FF at 40% load and a 130-kHz nominal frequency

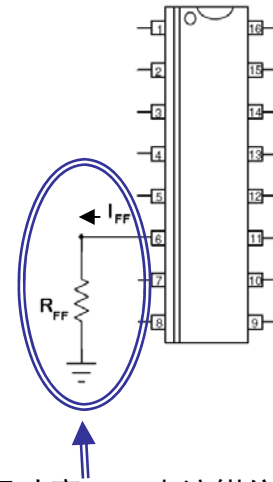
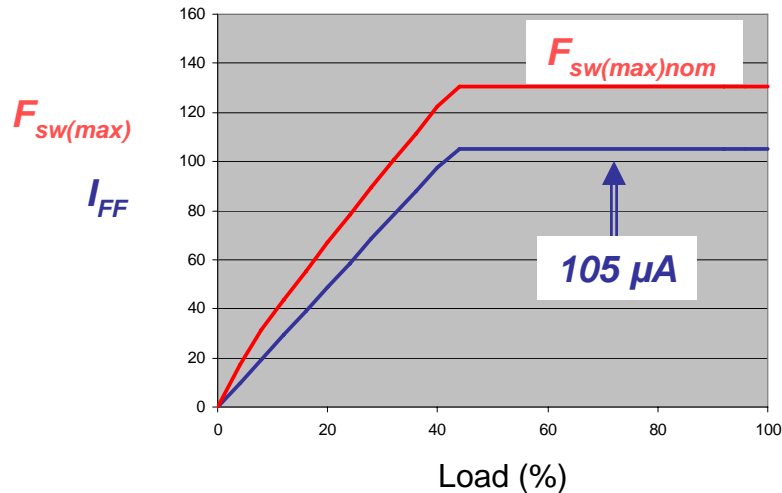

引脚6的输出电压正比于功率。 I_{FF} 电流钳位至 105 μA , 用于给振荡器电容充电及放电 Pin 6 pins out a voltage proportional to the power. The I_{FF} current is clamped to 105 μA and used to charge and discharge the oscillator capacitor

- ❑ 钳位频率逐渐减小 Gradual decay of the clamp frequency

- ❑ 工作不间断 No discontinuity in the operation

- ❑ 振荡器电容两端的电阻设定最低钳位频率(如20 kHz, 参见应用笔记AND8407)

A resistor across the oscillator capacitor sets a minimum clamp frequency (e.g., 20 kHz - see application note AND8407)

轻载工作 Light Load Operation

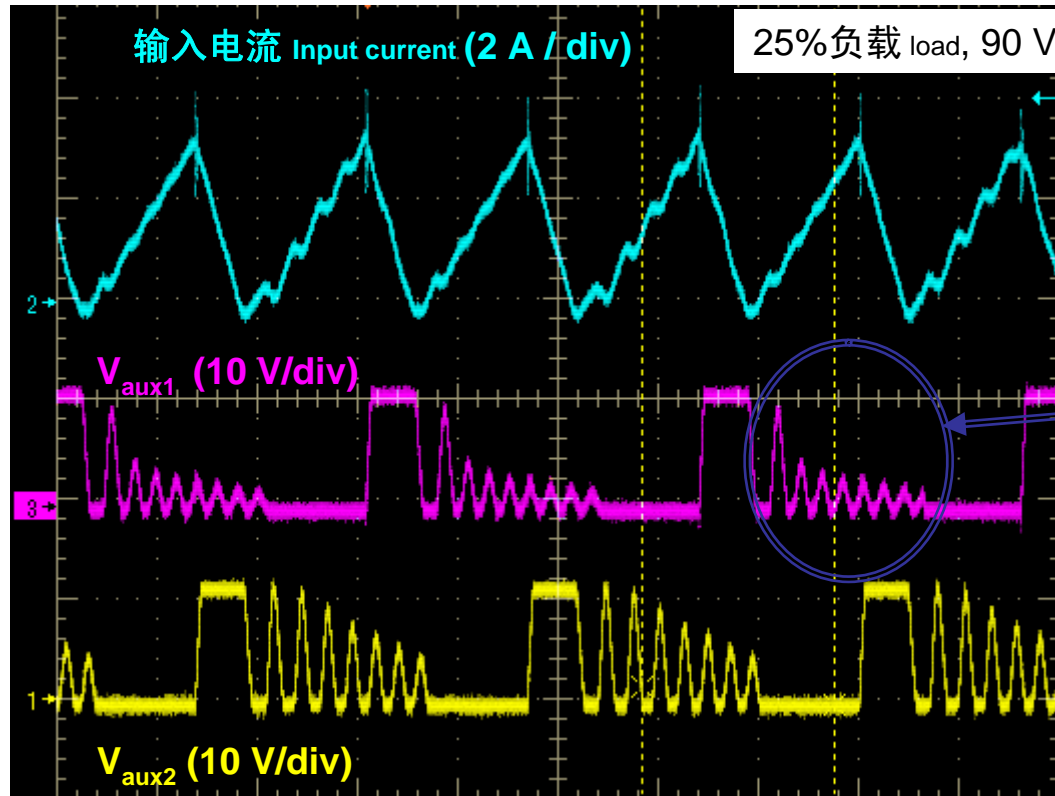

轻载时频率减小 Frequency is reduced at light load
→ 采用深度DCM工作，减小开关损耗
Heavy DCM operation to reduce the switching losses

死区时间 Dead-time

重负载条件下的CrM工作
CrM at heavy load conditions

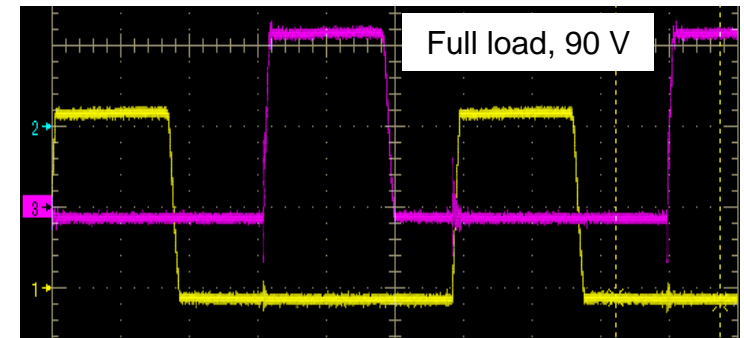

空载能耗 No Load Consumption

条件 Conditions	交流线路电压 Line Voltage (V)	输入能耗 Input Power (mW)
<input type="checkbox"/> No Frequency Foldback (pin6 grounded) <input type="checkbox"/> 2 separate V_{out} sensing networks for FB and OVP for a total 185- μ A leakage on the V_{out} rail	115	107
	230	138
<input type="checkbox"/> Frequency Foldback ($R_{FF} = 4.7 \text{ k}\Omega$) <input type="checkbox"/> 2 separate V_{out} sensing networks for FB and OVP for a total 185- μ A leakage on the V_{out} rail (*)	115	96
	230	134
<input type="checkbox"/> Frequency Foldback ($R_{FF} = 4.7 \text{ k}\Omega$) <input type="checkbox"/> one V_{out} sensing network for FB and OVP for a total 48- μ A leakage on the V_{out} rail	115	38
	230	82

- 数据系在300 W NCP1631演示板在测得 Measured on the 300-W NCP1631 demoboard
- 外部 V_{CC} 、3颗680 k Ω 电阻给X2电容放电 External V_{cc} , 3 * 680-k Ω resistors to discharge the X2 capacitors
- 频率反走技术不仅提升轻载能效，还提升空载条件下的能效 Frequency Foldback improves the efficiency in light load but also in no-load conditions

(*)默认演示板配置 Default demoboard configuration

NCP1631故障管理 NCP1631 Fault Management

输入欠压 Brown-out

欠压保护 Undervoltage protection

闩锁条件 Latch-off condition

晶圆过热 Die overtemperature

提升Vcc工作电平

Improper Vcc level for operation

Rt引脚提供的电流太小

Too low current sourced by the Rt pin

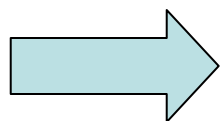
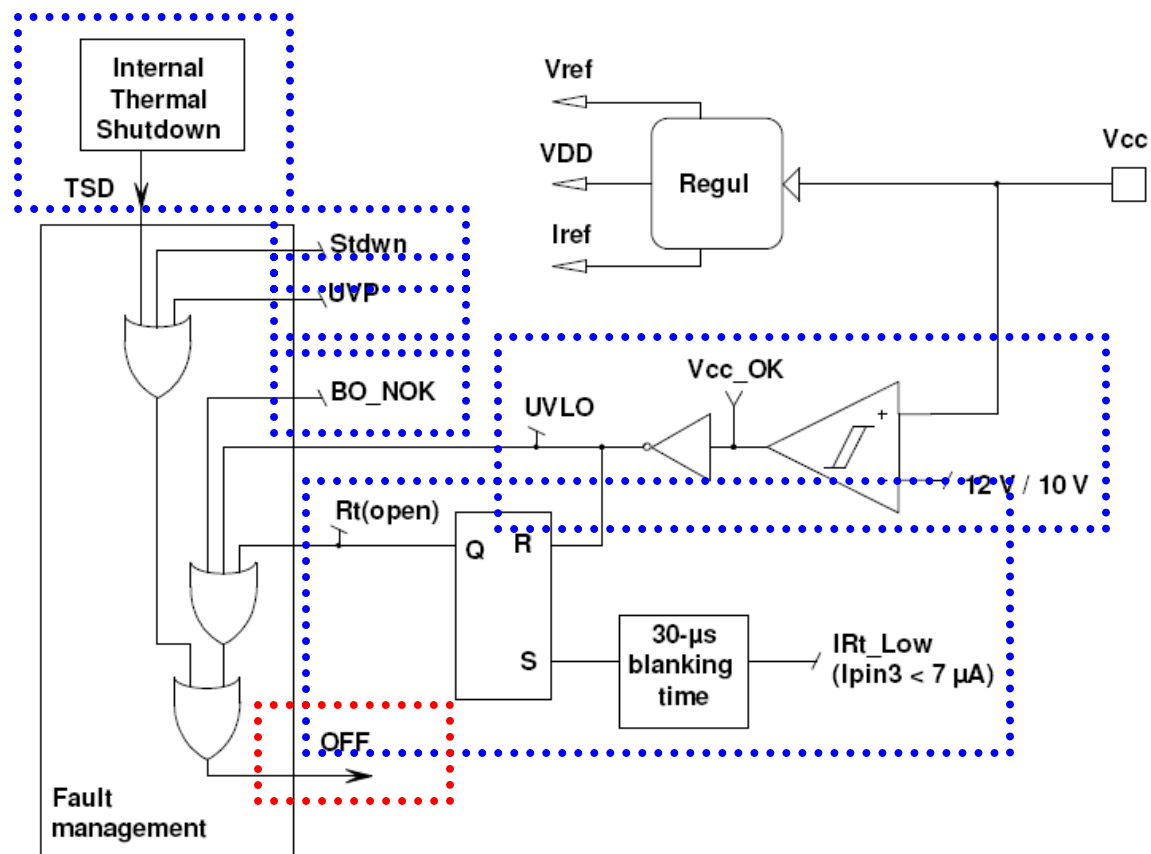

在关闭模式，电路主要元件休眠，能耗极低： $< 500 \mu\text{A}$

In OFF mode, the major part of the circuit sleeps and consumption is minimized to $< 500 \mu\text{A}$

NCP1631 过流保护(OCP)

NCP1631 Over Current Protection

2) I_{CS} 电流在CS引脚上保持0 V电压 I_{CS} current maintains 0 V on CS pin

$$-(R_{CS} \cdot I_{in}) + (R_{OCP} \cdot I_{CS}) = 0 \Rightarrow I_{CS} = \frac{R_{CS}}{R_{OCP}} \cdot I_{in}$$

3) 若 I_{CS} 超过 $210 \mu A$, 就触发过流保护 If I_{CS} exceeds $210 \mu A$, OCP is triggered

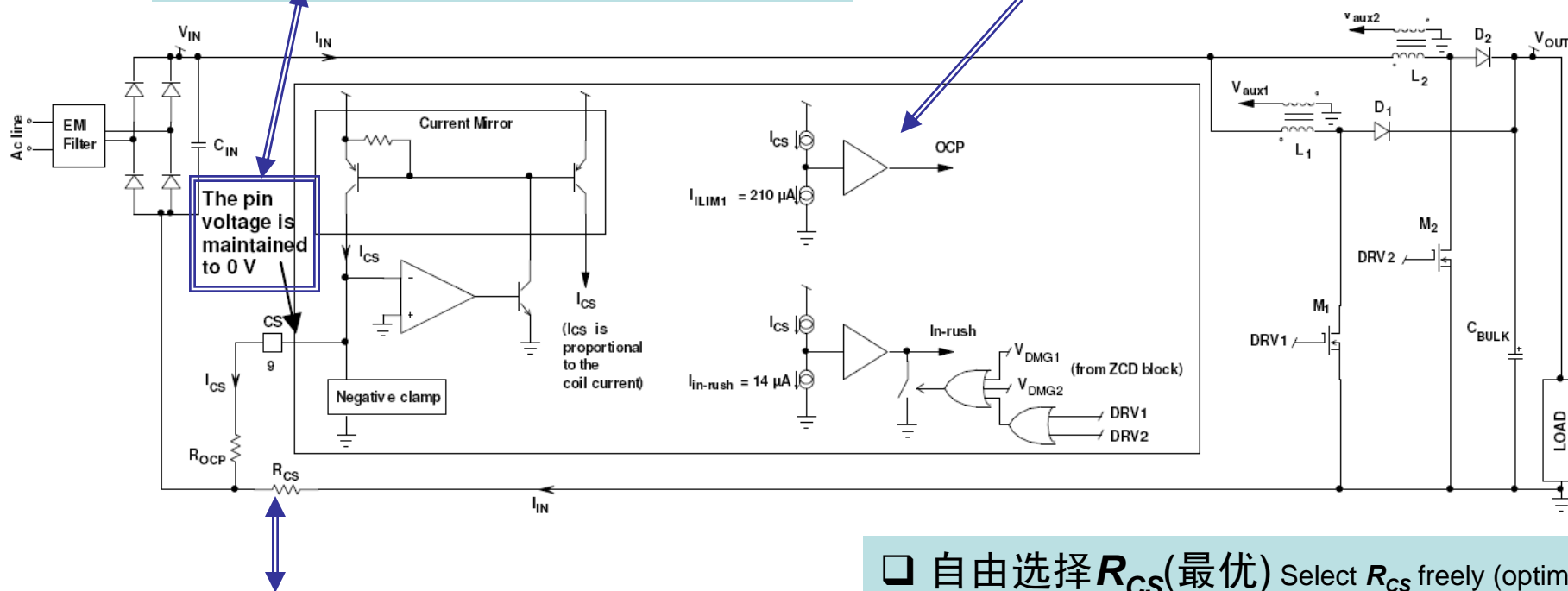

1) NCP1631 监测负电压 V_{CS} , 这电压正比于两个交错支路消耗的电流 I_{in} NCP1631 monitors a negative voltage, V_{CS} , proportional to the current drawn by both interleaved branches, I_{in} .

- 自由选择 R_{CS} (最优) Select R_{CS} freely (optimally)
- R_{OCP} 设定限流 R_{OCP} sets the current limit
- R_{CS} 损耗极低 Minimized losses in R_{CS}

NCP1631 过流保护(OCP)

NCP1631 Overcurrent Protection

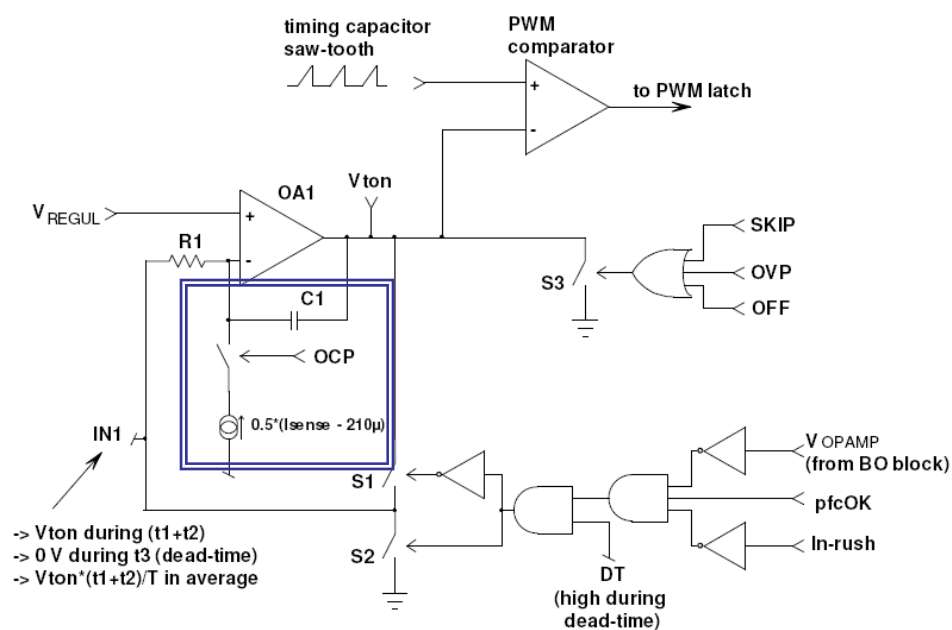

I_{CS} 大于 $210 \mu A$ 时, OCP 开关关闭, V_{TON} 处理运算放大器中注入的电流等于 $0.5 \cdot (I_{CS} - 210 \mu A)$ When $I_{CS} > 210 \mu A$, the OCP switch closes and a current equal to $0.5 \cdot (I_{CS} - 210 \mu A)$ is injected into the negative input of the V_{TON} processing opamp

→ 导通时间以与过流幅度成比例地急剧缩短 the on-time sharply reduces proportionally to the magnitude of the over-current event.

□ 工作无间断, 仍维持异相工作 No discontinuity in the operation, out-of-phase operation is maintained

□ 在额定瞬态条件期间不需要防止OCP动作 No need for preventing OCP from tripping during a normal transient

□ 能够精确限制电流 The current can be accurately limited

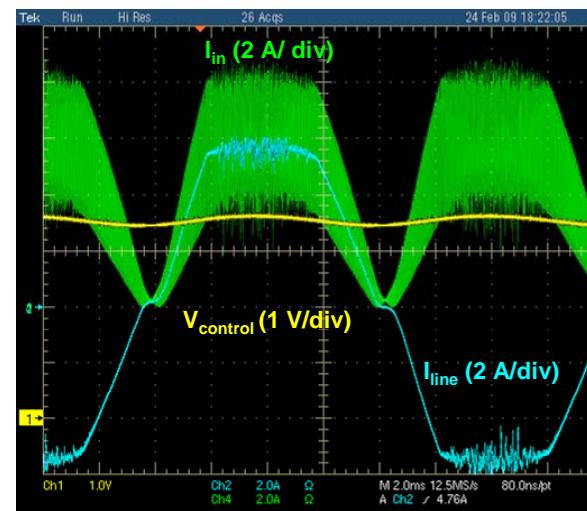

NCP1631浪涌电流检测

NCP1631 In-rush Current Detection

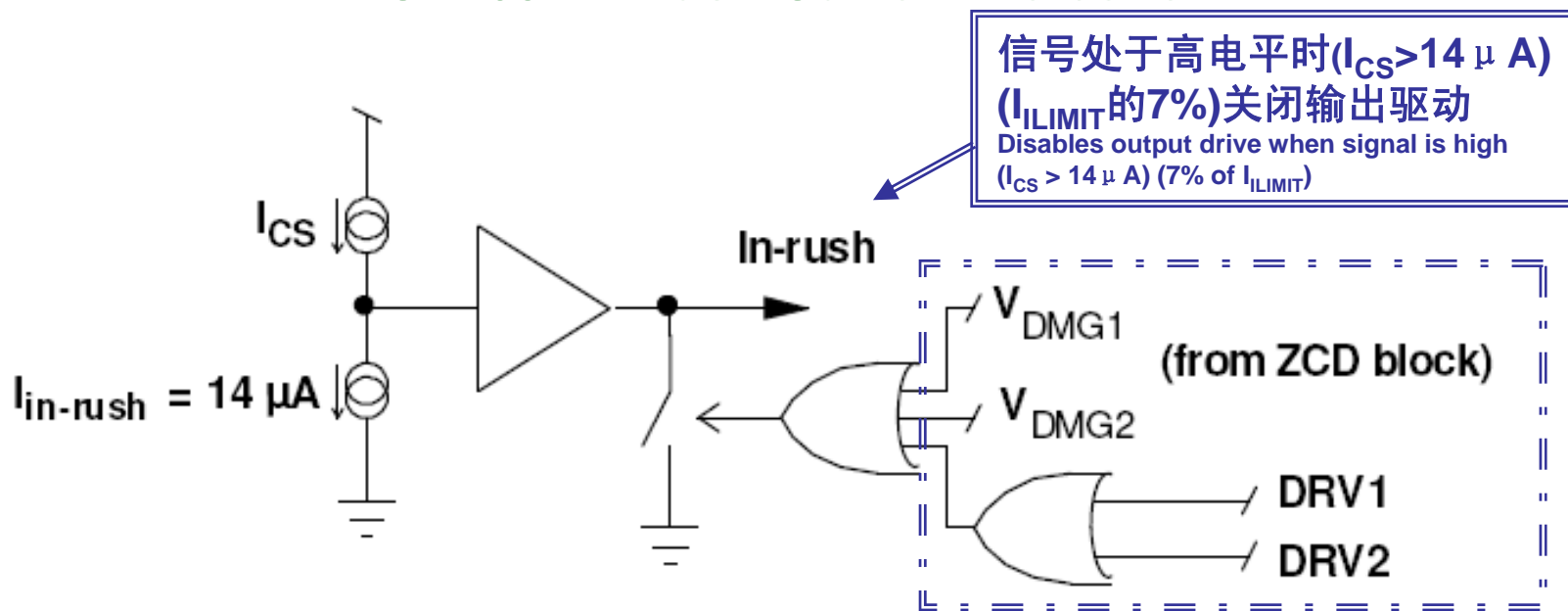

大电容插入主电源电路时，突然充电至电源线路电压，充电电流(浪涌电流)极大。这时候驱动导通可能会损坏MOSFET。 When plugged into the mains, the bulk capacitor is abruptly charged to the line voltage and the charge current (in-rush current) is huge. Drive turn-on during this time can damage the MOSFETs.

一旦电路开始工作，电路将把浪涌保护接地
Circuitry to ground the In-rush protection once the circuit begins operation

NCP1631 过压保护

NCP1631 Over Voltage Protection

- ❑ 反馈(FB)及过压保护(OVP)各有单独引脚(提供冗余) Separate pins for FB and OVP (redundancy)
- ❑ 这两种功能使用相同的2.5 V内部参考, 用于**简易、精确地设定 OVP电平** The two functions share the same 2.5-V internal reference for an **eased and accurate setting of the OVP level**

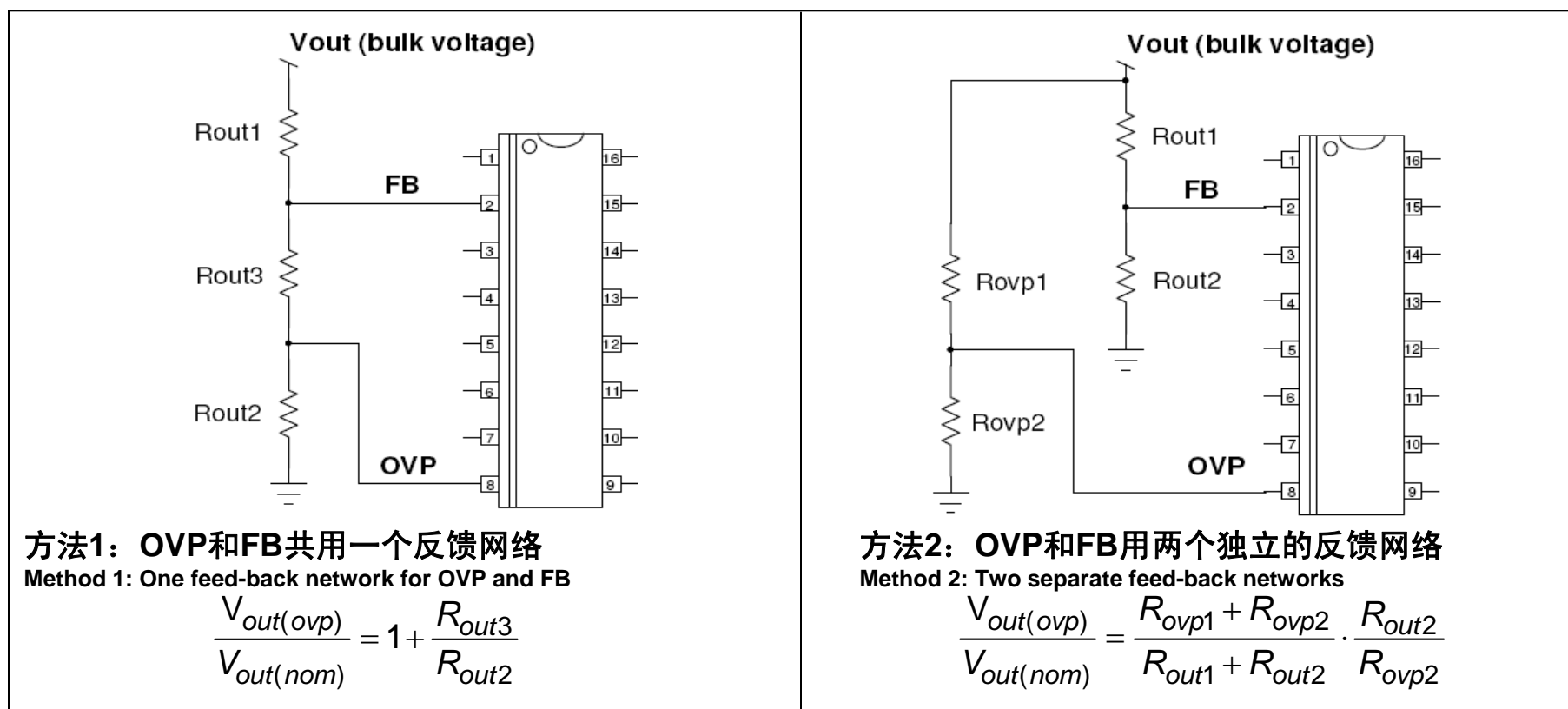

50 ms消隐时间的输入欠压(BO)保护

Brown-out Protection with a 50-ms Blanking Time

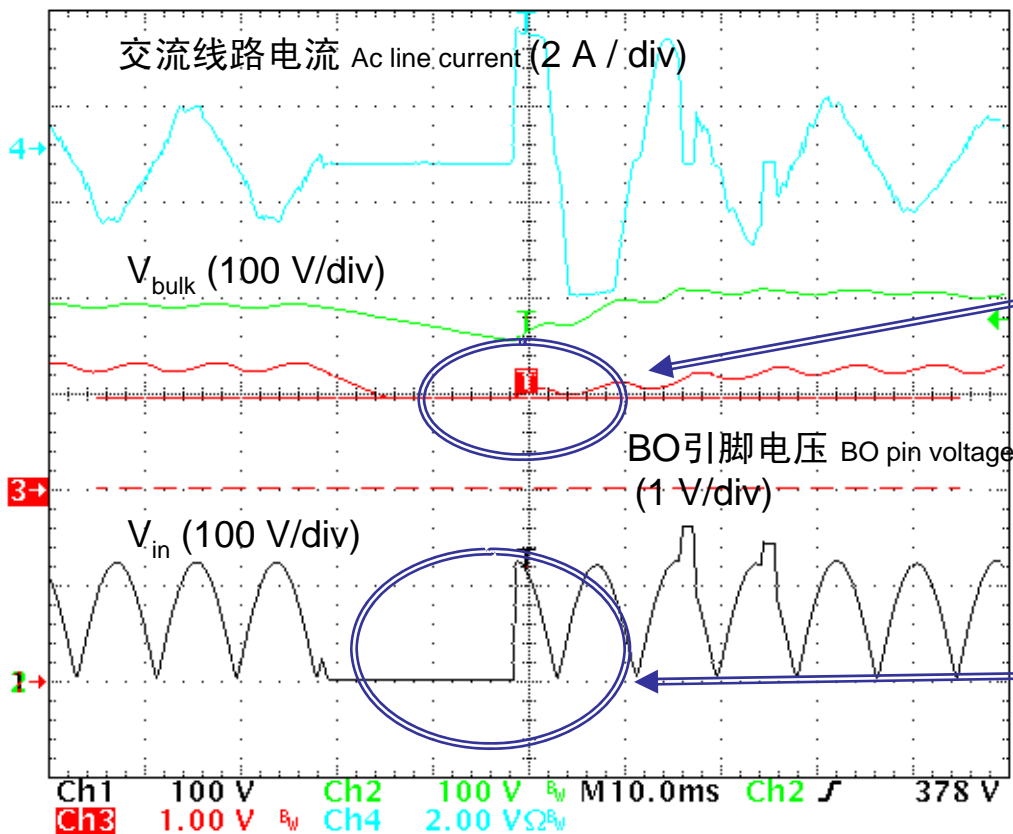

对于消隐时间而言，BO引脚电压维持在BO阈值附近，当交流线路恢复时不延迟电路重启 For the blanking time, the BO pin voltage is maintained around the BO threshold not to delay the circuit restart when the line has recovered

20 ms时间的线路中断
20-ms line interruption

- ❑ 忽略时间短于50 ms的主电源中断 Mains interruptions shorter than 50 ms are ignored
- ❑ 消隐时间帮助满足维持时间要求 The blanking time helps meet hold-up time requirements
- ❑ BO引脚电压用于前馈 The BO pin voltage serves for feedforward

NCP1631 pfcOK/REF5V信号

NCP1631 pfcOK / REF5V Signal

- pfcOK信号能用于启用/关闭下行转换器 The pfcOK signal can be used to enable/disable the downstream converter.
- PFC段正常工作时pfcOK信号是高电平(5V)， 否则是低电平 It is high (5 V) when the PFC stage is in normal operation and low otherwise.
- pfcOK信号为低电平的条件 The pfcOK signal is low:
 - 任何时候PFC因检测到重要故障而关闭时(欠压锁定条件、热关闭、欠压保护、输入欠压、闩锁/关闭、 R_f 引脚开路) Any time the PFC is off because a major fault is detected (UVLO condition, thermal shutdown, UVP, Brown-out, Latch-off / shutdown, R_f pin open)
 - PFC段获得额定大电压前的启动相位期间 For the start-up phase of the PFC stage until the nominal bulk voltage is obtained
- pfcOK引脚能用作5 V电源(电流能力5 mA) The pfcOK pin can be used as a 5-V power source (5-mA capability)

NCP1631 Excel Spreadsheet

J. Terchi / August 2009

Please enter your specification

Vac	(Hz)	60	Ac line frequency
VacLL	(V)	30	Ac line rms lowest level (generally 85 V or 90 V in wide mains applications)
VacHL	(V)	265	Ac line rms highest level (generally 265 V in wide or European mains applications)
Vout(nom)	(V)	330	Wished regulation level for the output voltage (generally 330 V or 400 V in wide mains apps)
Vovp	(V)	410	Over-Voltage Protection Level
eff	(%)	34	Expected efficiency at low line, full load - use 34 % as a default value if you don't know
Pout	(w)	300	Maximum output power
Pout(FF)	(w)	150	Output power below which the PFC stage should reduce the switching frequency (frequency Foldback)
Fosc	(kHz)	240	Oscillator frequency (The frequency in each branch of the interleaved PFC is Fosc/2)
Rds(on)	(Ω)	0.33	MOSFET on-time resistance @ 25 °C
Thold-up	(ms)	0	Hold-up time. Put 0 if no hold-up time is specified or if you don't know.
Voutjmin	(V)	330	Minimum output Voltage you can accept at the end of the hold-up time - Don't fill this cell or put any value if no hold-up time is specified
%DVpk-pk	(%)	7	Peak to peak low frequency ripple acceptable across the bulk capacitor as a percentage of "Vout(nom)". Choose 7% if you don't know.
Fc	(Hz)	20	Targeted Crossover Frequency

Cells to be filled
Proposed values

Power Components

Cbulk(min)	(μ F)	75	Minimum Cbulk capacitance meeting the low frequency ripple and hold-up time constraints (*)
Cbulk	(μ F)	100	Your selection
Lcalc	(μ H)	142	Proposed minimum L1 and L2 inductance not to have a permanent DCM operation in any branch (recommended)
L1, L2	(μ H)	150	Your inductance choice. It is recommended to select it higher or equal to "Lcalc"
IL1(max), IL2(max)	(A)	5.0	Maximum current flowing through L1 and L2
IL1(rms), IL2(rms)	(A)	2.0	Maximum rms current in L1 and L2
Np/Naux1(min)	(-)	15.3	Minimum Turn Ratio (Naux: turns number for auxiliary winding)
Np/Naux	(-)	10.0	Your selected turns ratio
P(bridge)	(w)	6.4	Diode bridge losses assuming a 1-V forward voltage per diode
Pon(L1), Pon(L2)	(w)	2.4	M1 or M2 conduction losses assuming that Rds(on) doubles at the highest junction temperature of your application
P(D1), P(D2)	(w)	0.4	losses in each of the D1 and D2 boost diodes (assuming a 1-V forward voltage)

(*) Do not forget to check that the ESR is low enough to avoid any over-heating of the bulk capacitor. You can use 1.21 A as a starting value for the bulk capacitor rms current (estimation based on AND8355 or AND8407 equation). Doublecheck on the bench that the bulk capacitor heating is not excessive

Brown-Out Circuitry

VacBOH	(V)	81	
VacBOL	(V)	72	
Fbo / Fac	(%)	10	You can take 10% by default
Cbo_calc	(nF)	225	
Cbo	(nF)	220	Your Cbo choice (standard value close to "Cbo_calc")
Rbo1	(Ω)	7413	
Rbo2	(Ω)	120	
Kbo	(%)	1.53	BO scale down factor (for information)

Power Capability Setting

Rt(min)	(Ω)	14.0	
Rt	(Ω)	16.2	Your Rt choice. Select a resistor at least 15% higher for margin
PinHL	(w)	425	Power capability of your PFC stage based on the selected "Rt"

Frequency Control

Cosc(th)	(pF)	217	
Cosc	(pF)	220	The oscillator capacitor you actually select
Fsw(max)	(kHz)	118	Clamp Frequency in each branch (no Frequency Foldback)
Rff	(Ω)	7.3	Pin6 resistor
Rfmin	(Ω)	220	Resistor placed across Cosc to set "Fsw(min)".
Fsw(min)	(kHz)	13.1	Minimum frequency per branch resulting from your "Rfmin" choice

Feed-back and OVP arrangements and Compensation

Rfb2	(Ω)	27	You can choose 27 k by default
Rfb0	(Ω)	1.38	
Rfb1	(Ω)	4400	
Cp_calc	(nF)	74	
Cp	(nF)	100	
Cz_calc	(μ F)	1.11	The computation of the compensation elements ("xz_calc") targets the specified crossover frequency and 60° as the phase margin
Cz	(μ F)	1.00	(asymptotic approximation)
Rz_calc	(Ω)	31.8	
Rz	(Ω)	33.0	
Fc	(Hz)	20.7	Crossover frequency and phase margin resulting from the selected compensation elements (asymptotic approximation)
ϕ_m	(°)	53.7	

Current Sense Network

Iin(max)	(A)	6.3	Maximum input current
Rsense_calc	(m Ω)	51	Value that makes the Rsense dissipation = (0.2% * Pout)
Rsense	(m Ω)	50	Your "Rsense" choice
pRsense	(mW)	560	Losses resulting from your Rsense choice (full load, low line)
Rocp	(Ω)	1.5	Value resulting from your Rsense choice

ZCD resistors

Rzcd1(min), Rzcd2(min)	(Ω)	19	Minimum value of the Rzcd resistor
------------------------	--------------	----	------------------------------------

Generic NCP1631 Application Schematic

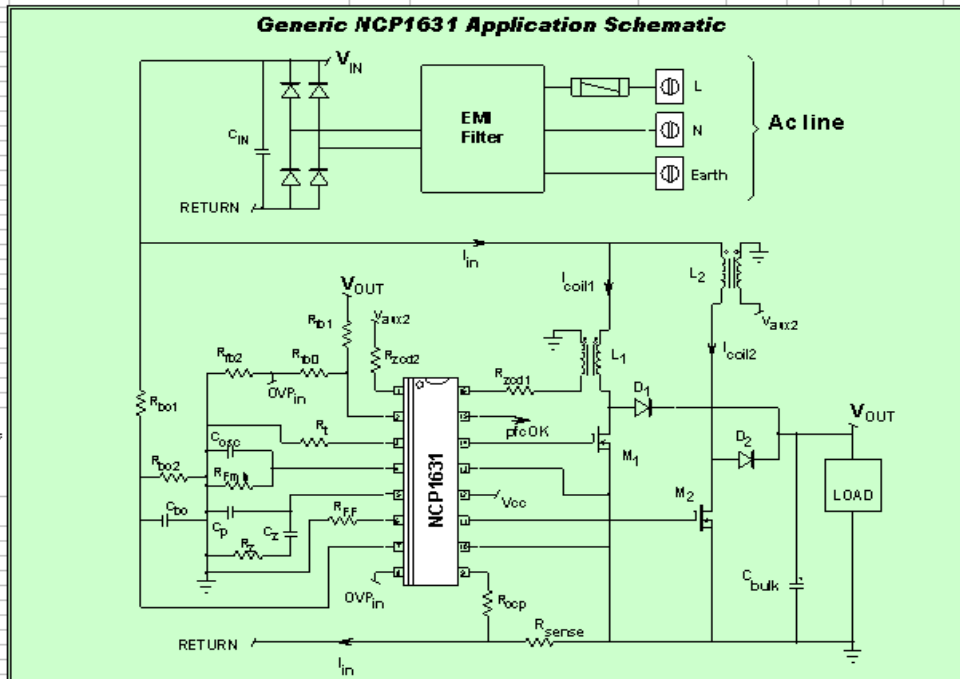

□ 使用简单易用的Excel电子表格来计算外部元件(www.onsemi.cn) A (simple but easy to use) Excel Spreadsheet (www.onsemi.com) computes the external components



议程 Agenda

□ 简介 Introduction:

- 交错式PFC基础知识 Basics of interleaving
- 主要优势 Main benefits

□ NCP1631: 新颖的交错式PFC控制器 NCP1631: a novel controller for interleaved PFC

- 异相管理 Out-of-phase management
- NCP1631支持使用较小电感 The NCP1631 allows the use of smaller inductors
- 主要功能 Main functions

□ 实验结果及性能 Experimental results and performance

- 一般波形 General waveforms
- 能效 Efficiency

□ 总结 Summary

NCP1631演示板

NCP1631 Demoboard

宽电压范围、
300 W PFC预
转换器

Wide mains, 300 W,
PFC pre-converter

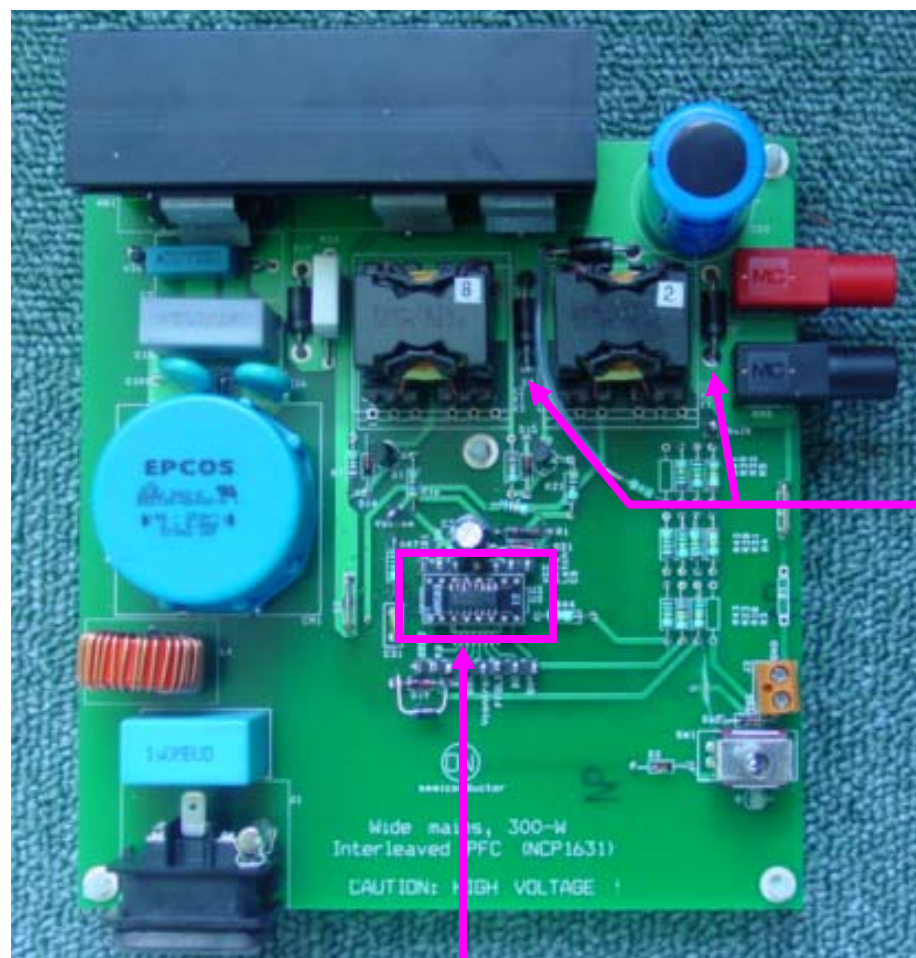

MUR550

NCP1631

NCP1631演示板电路图

NCP1631 Demoboard Schematic

如果 V_{CC} 超过 17.5 V，电路闪烁关闭。能用作热保护
 The circuit is latched off if V_{CC} exceeds 17.5 V.
 Could be used for thermal protection

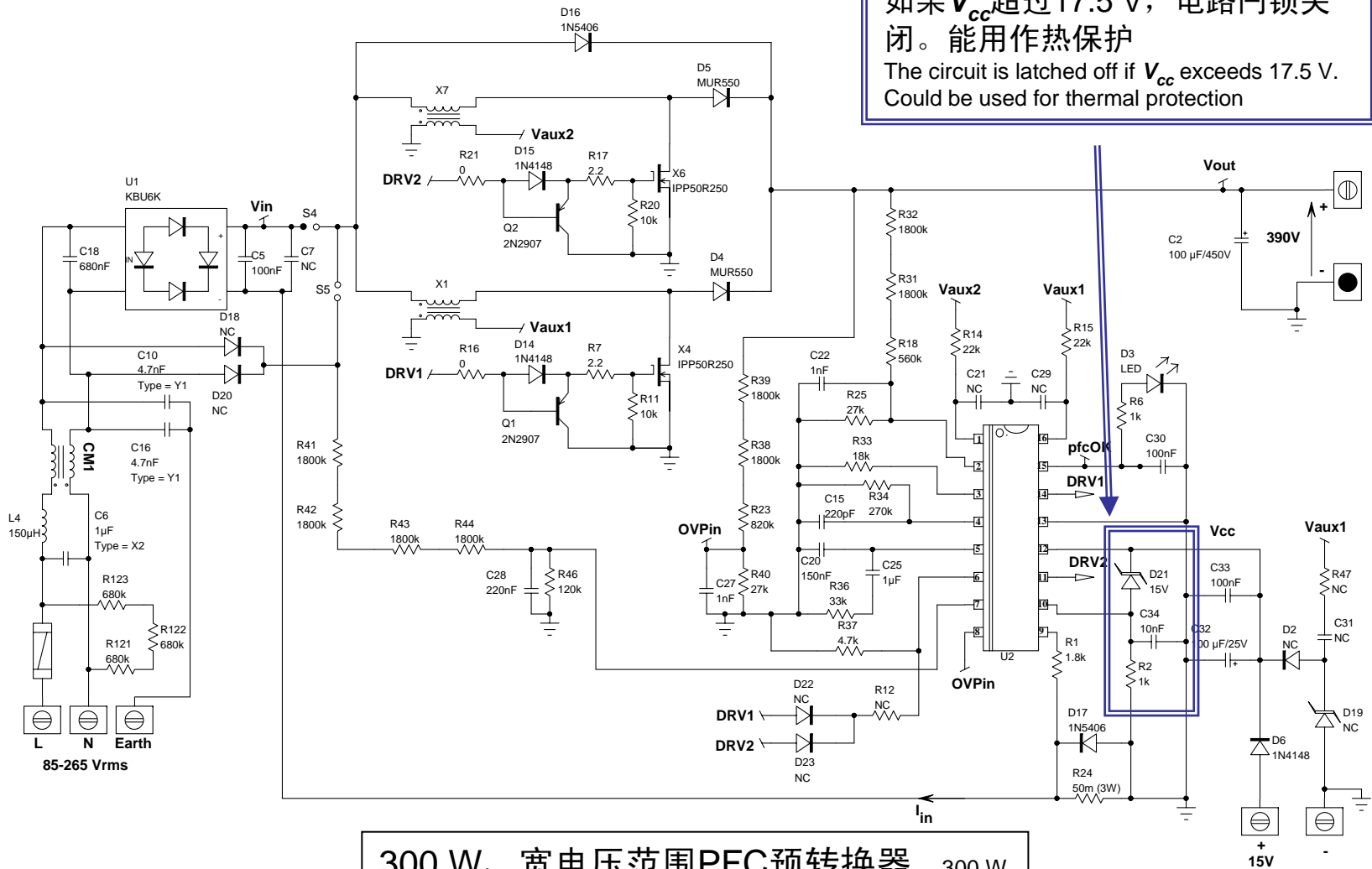

300 W、宽电压范围PFC预转换器 300 W,
 wide mains PFC pre-converter

输入电压及电流 Input Voltage and Current

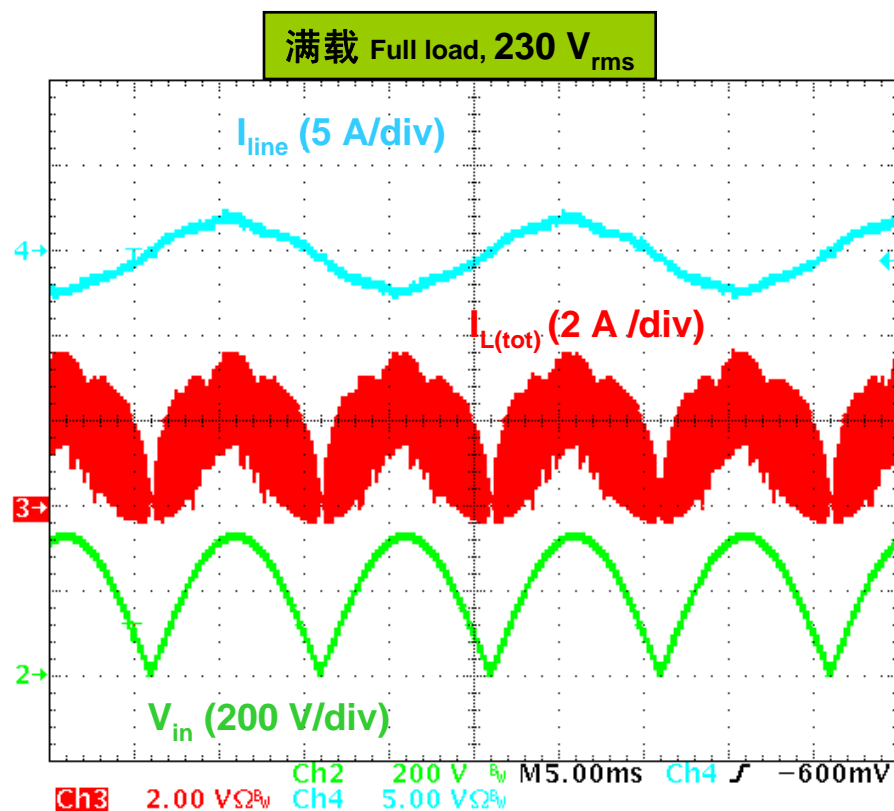
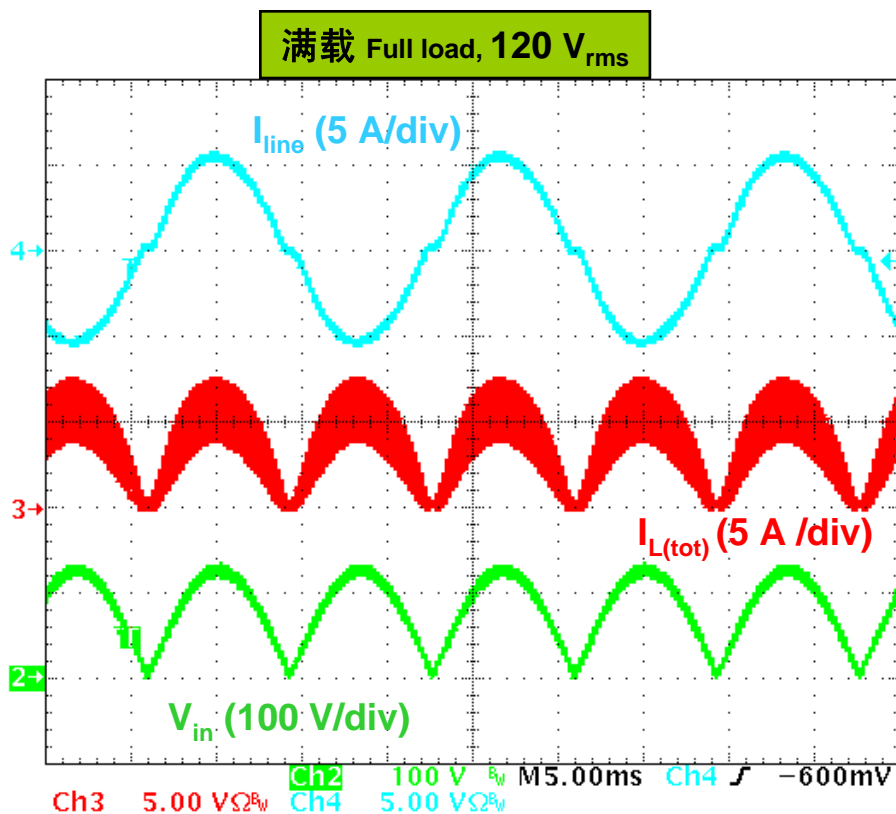

- 正如预料，输入电流看上去象是CCM波形 As expected, the input current looks like a CCM one
- 高交流线路时，频率反走影响纹波 At high line, frequency foldback influences the ripple

波形图放大 Zoom of the Precedent Plots

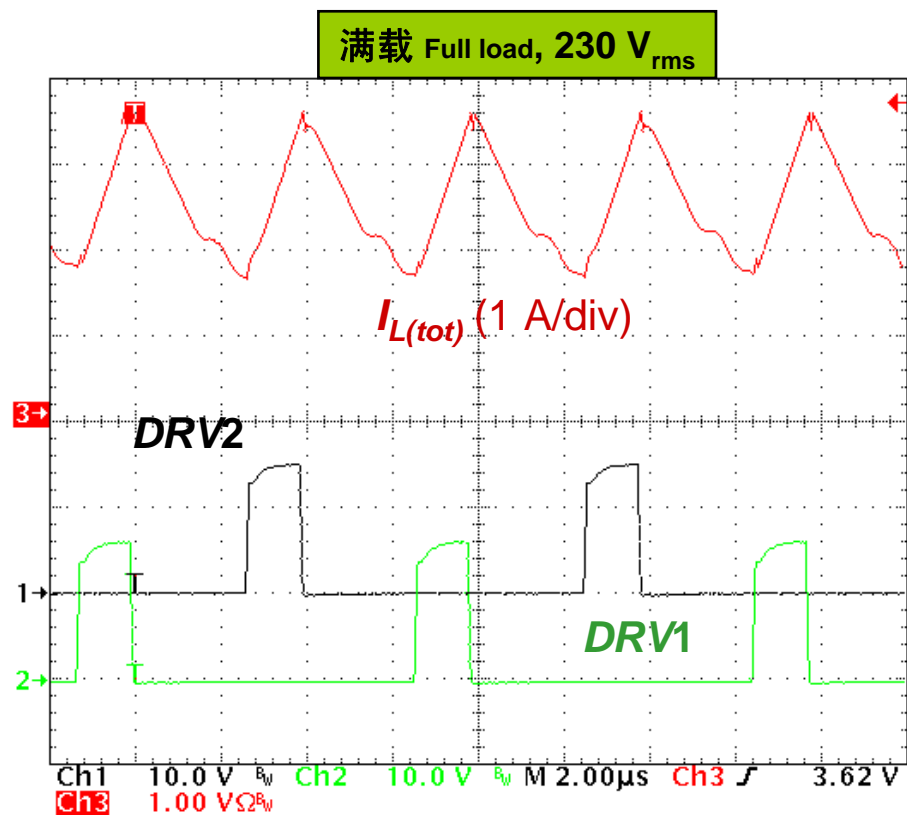
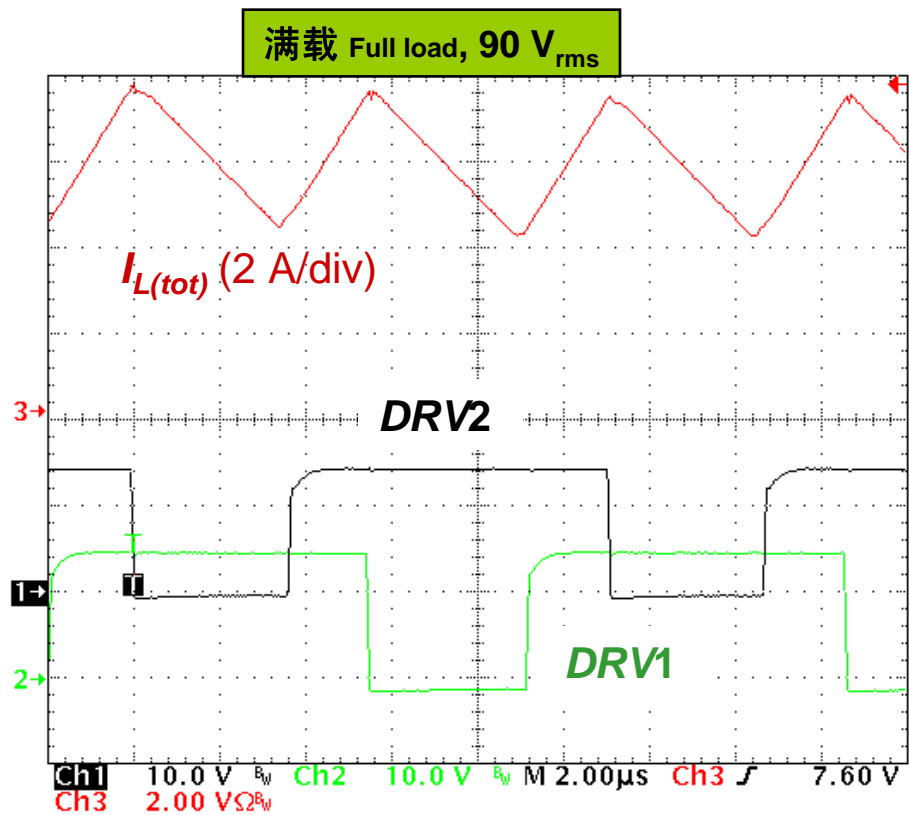

- 这些图在正弦波形顶部获得 These plots were obtained at the sinusoid top
- 电流以每个相位频率的2倍摆动 The current swings at twice the frequency of each phase
- 低及高交流线路时相移充分达到180° At low and high line, the phase shift is substantially 180°

充电序列 Refueling Sequences

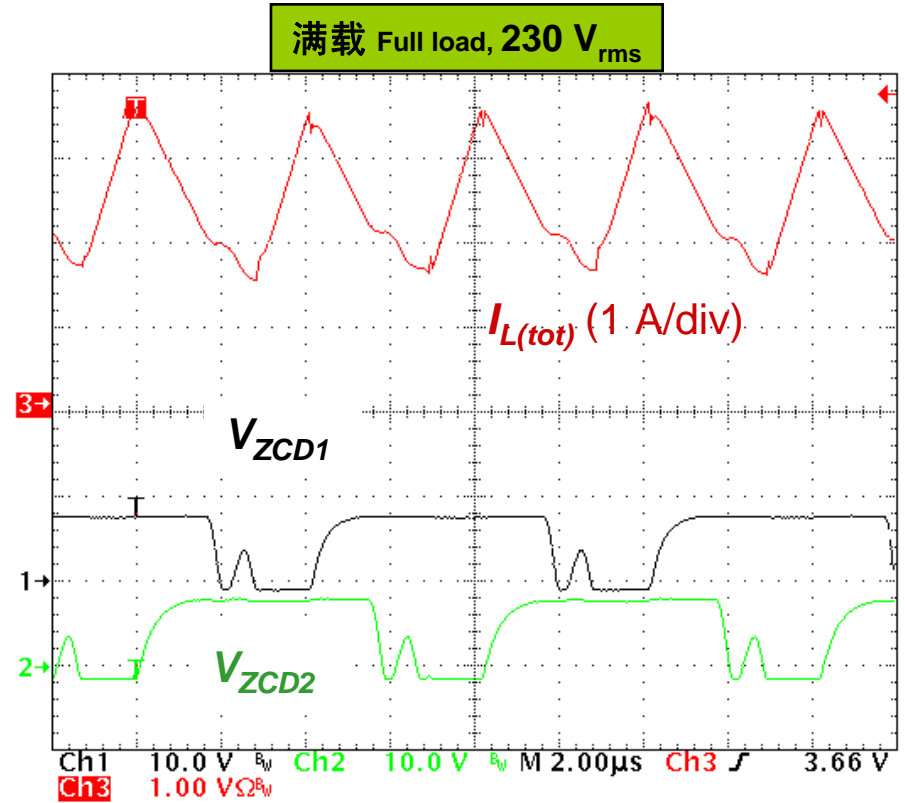
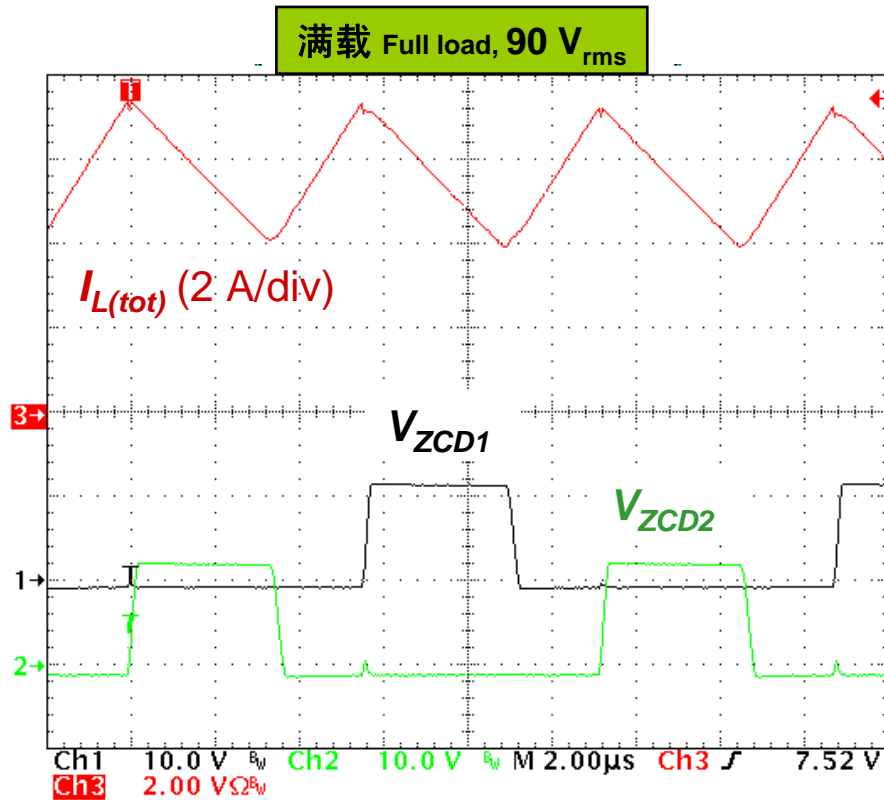

- CrM的低交流线路电压时谷底开关 CrM at low line with valley switching
- 高交流线路电压时固定频率工作(频率钳位) Fixed frequency operation at high line (frequency clamp)
- 两种情况下都异相工作 Out-of-phase operation in both cases

能效测量 Efficiency Measurements

- ❑ 输出电压通常为390 V The output voltage is generally 390 V
- ❑ 对于300 W应用而言,输出电流是: For a 300-W application, the output current is:
 - 满载时770 mA 770 mA at full load
 - 20%负载时154 mA 154 mA at 20% of the load
- ❑ 两类电流一般以相同工具测量 Both currents are generally measured with the same tool
- ❑ 处于20%负载时, 输入功率为63 W If @ 20% of the load, the input power is 63 W
- ❑ 输出电流1 mA误差会造成: 1-mA error in I_{out} leads to
 - $I_{out} = 153 \text{ mA} \rightarrow$ 能效 $Eff = 100 \times 390 \times 0.153 / 63 = 94.7 \%$
 - $I_{out} = 155 \text{ mA} \rightarrow$ 能效 $Eff = 100 \times 390 \times 0.155 / 63 = 95.9 \%$
- ❑ 1 mA误差导致1.2%的能效差别! A 1-mA error causes a 1.2% difference in the efficiency!
- ❑ 在10%及20%负载条件下测量时需要细心! Measurements @ 10% and 20% of the load need care!!!

能效测量 Efficiency Measurements

- ❑ 能效并不只取决于控制模式 The efficiency does not only depend on the control mode
- ❑ 电感、MOSFET、二极管、EMI滤波器等都会影响能效 The inductor, the MOSFETs, diodes, EMI filter... play a role
- ❑ 例如，我们可以比较采用200 μH PQ2625电感与采用150 μH PQ2620电感时的能效差别 For instance, if we compare the efficiency with a 200- μH PQ2625 inductor to that with a 150- μH PQ2620 one:

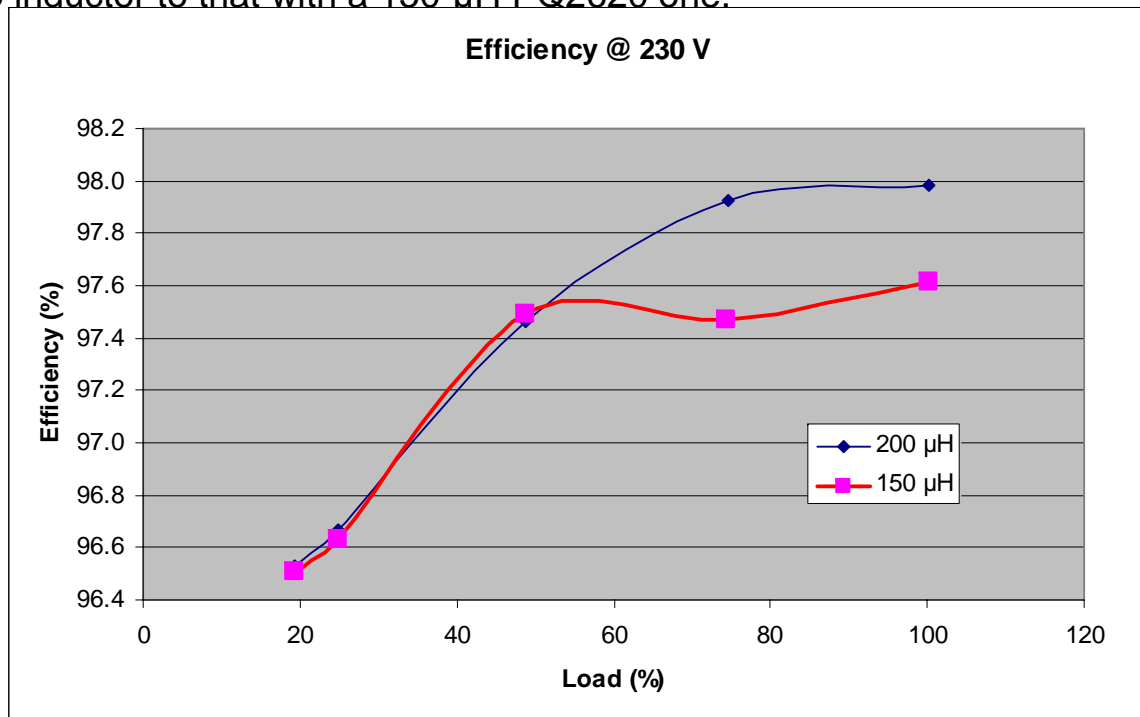

频率反走限制轻载时的能效差别
Frequency Foldback limits the difference at light load

演示板能效 Demoboard Efficiency

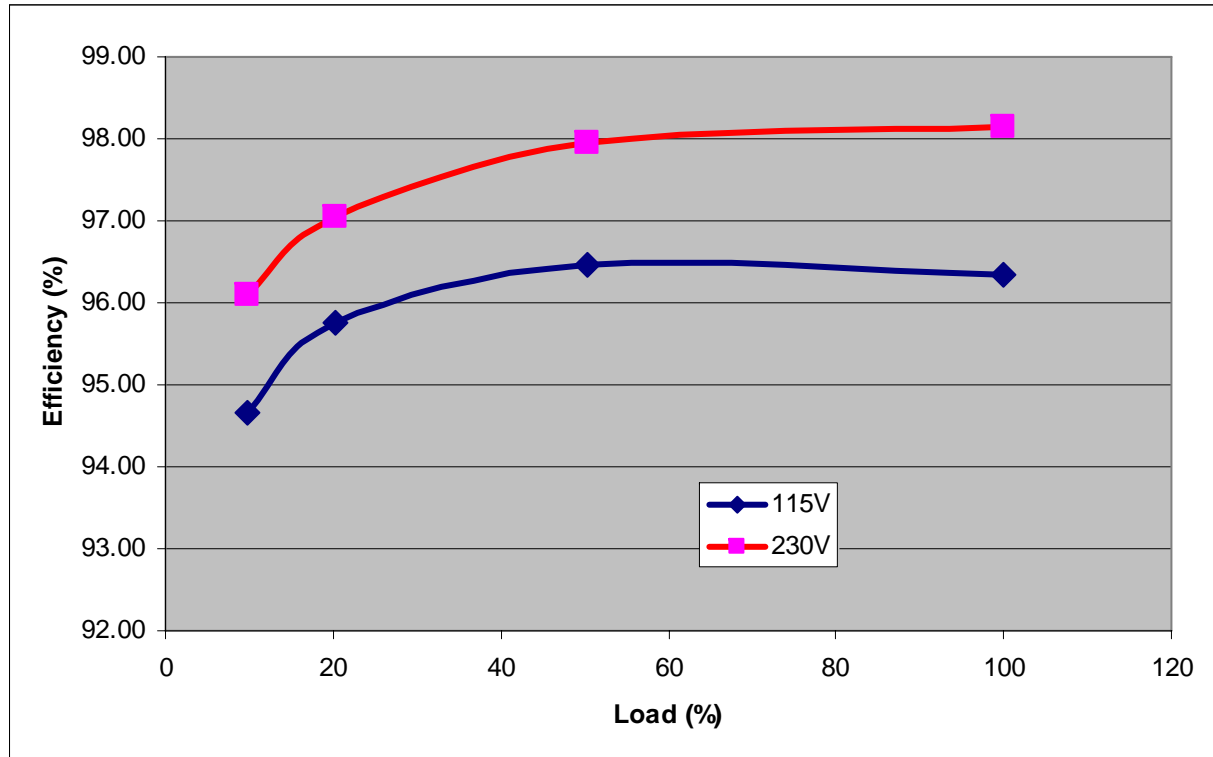

- ❑ 在20%至100%负载范围，能效保持为 In the 20% to 100% range, the efficiency remains:
 - 低线路电压时高于95.8% > 95.8% at low line
 - 高线路电压时高于97.0% > 97.0 % at high line
- ❑ 更多信息请访问www.onsemi.cn，参见NCP1631EVB/D资料 Refer to NCP1631EVB/D at www.onsemi.com for details

调节频率反走 Tweaking Frequency Foldback ...

□ 能在pfcOK(5 V)及频率反走引脚间增加电阻

A resistor can be added between the pfcOK (5 V) and frequency foldback pins

□ 这样做，频率钳位会大幅减弱

Doing so, the frequency clamp decays more sharply:

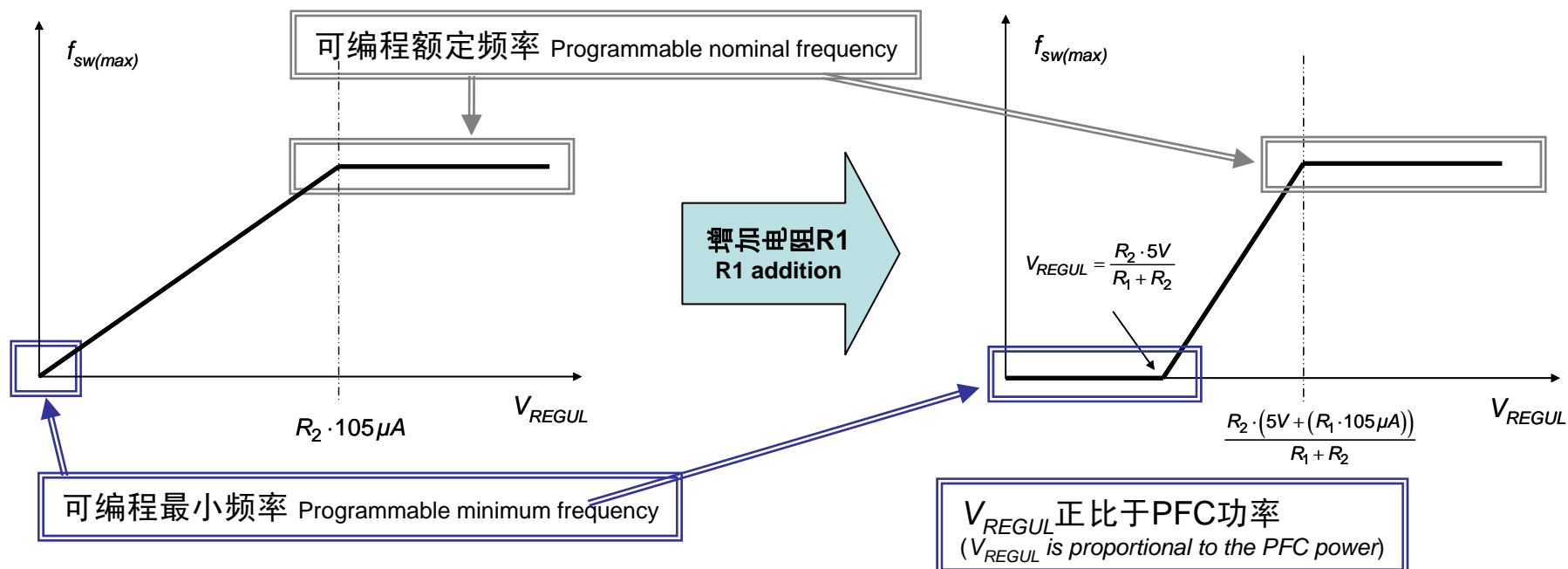
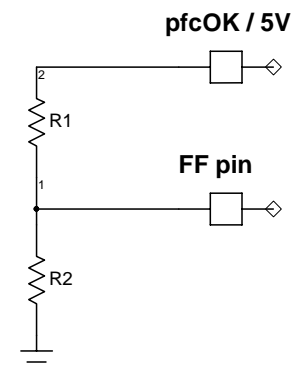

能效提升 Efficiency Improvement

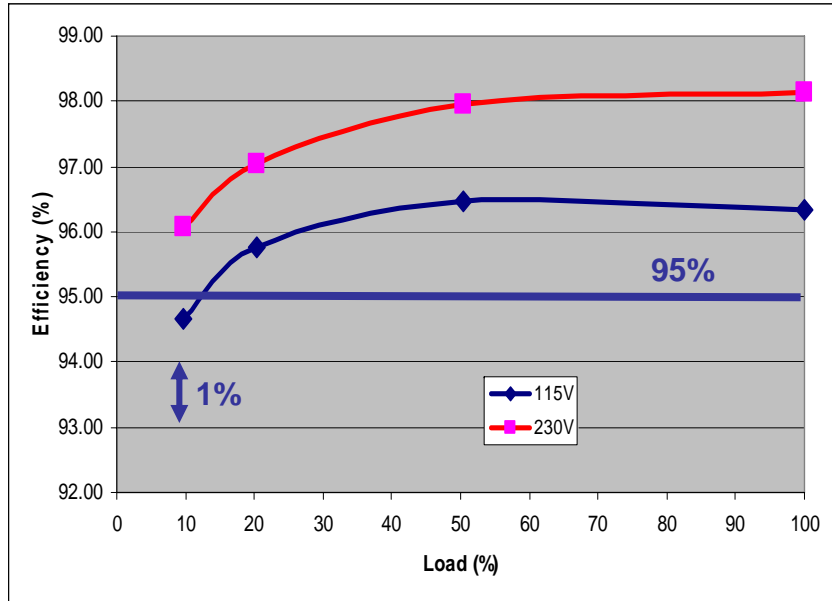

增加R1
R1 addition

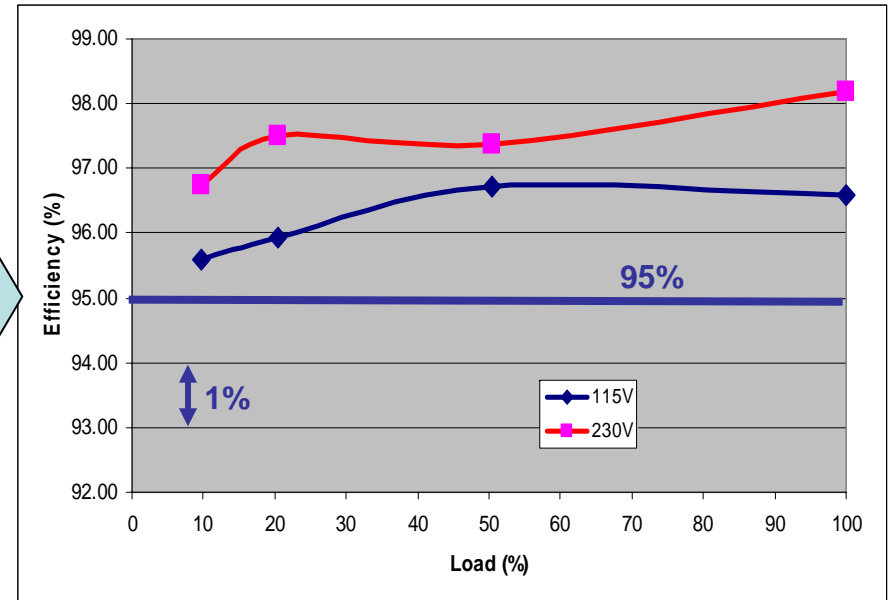

- ❑ 振荡器引脚上的电阻能设定最低频率 A resistor on the oscillator pin sets the minimum frequency
- ❑ 增加电阻 R_1 时, PFC段在10%和20%负载条件下工作在最低频率 (20 kHz) With R_1 , the PFC stage operates at the minimum frequency (20 kHz) at 10% and 20% of the load
- ❑ 调节频率反走进一步提升轻载能效 The tweak further improves the light load efficiency

议程 Agenda

- 简单 Introduction:
 - 交错式PFC基础知识 Basics of interleaving
 - 主要优势 Main benefits
- NCP1631: 新颖的交错式PFC控制器 NCP1631: a novel controller for interleaved PFC
 - 异相管理 Out-of-phase management
 - NCP1631支持使用较小电感 The NCP1631 allows the use of smaller inductors
 - 主要功能 Main functions
- 实验结果及性能 Experimental results and performance
 - 一般波形 General waveforms
 - 能效 Efficiency
- 总结 Summary

总结 Summary

- ❑ 交错式PFC支持使用较小的元器件、改善热性能、增强CrM功率范围并减小电流纹波 Interleaved PFC allows use of smaller components, improves thermal performance, increases the CrM power range and reduces current ripple.
- ❑ NCP1631以单颗IC方案集成构建坚固及紧凑的2相交错式PFC段所需的全部特性，且外部元件极少 The NCP1631 provides a single IC solution which incorporates all the features necessary for building a robust and compact 2-phase interleaved PFC stage with minimal external components.
- ❑ FCCrM及频率反走支持使用小电感在完整负载范围内的高能效工作 Its FCCrM and frequency foldback allows an efficient operation over the load range with small inductors

For More Information

- ❑ View the extensive portfolio of power management products from ON Semiconductor at www.onsemi.com
- ❑ View reference designs, design notes, and other material supporting the design of highly efficient power supplies at www.onsemi.com/powersupplies