

DESCRIPTION

Highly sensitive triggering levels, the HMCR100-x Series SCRs is suitable for all applications, where the available gate current is limited, such as capacitive discharge ignitions, motor control in kitchen aids, overvoltage crowbar protection in low power supplies....

- 产品特点: 先进的玻璃钝化芯片工艺, 具有灵敏的控制极触发电流, 通态压降小, 高灵敏触发单向可控硅。
- 主要用途: 广泛应用于点火器、负离子发生器、雾化器、镇流器、漏电保护器; 各种万能开关器、小型马达控制器、彩灯控制器
- 主要用途: 漏电保护器、灯具继电器驱动器、逻辑集成电路驱动、大功率可控硅门极驱动、摩托车点火器等线路功率控制。
- 代替型号: PCR406、PCR606、BT169GW、MCR100-6、MCR100-8、MCK100-6、MCK100-8、X00602MA、X00602MN、X00619、
- 代替型号: P0111DA、P0115MA、P0118MA、P0111DN、P0111MN、P0115MN、P0118MN、EC103D1、EC103D1W、MCR08BT1

Product Model Reference & Naming 【产品型号参考及型号命名】

0.8A (Amperes)	产品型号列表、封装区分、型号对照电压值						I _{GT}
	封装标识	400V	600V	700V	800V	900V	
TO-92	A	MCR100-6	MCR100-8	MCR100-9	MCR100-10	MCR100-12	≤200μA ① I _{GT} Class
SOT-23	MM	MMCR100-6	MMCR100-8	MMCR100-9	MMCR100-10	MMCR100-12	
SOT-89	M	MCR100-6M	MCR100-8M	MCR100-9M	MCR100-10M	MCR100-12M	
SOT-223	S	MCR100-6S	MCR100-8S	MCR100-9S	MCR100-10S	MCR100-12S	
Remarks (说明)		标准品种	高压品种	高压品种	高压品种	特制高压	

PINNING: Insulated Package

Pin in Symbol and Description			
1	K	Cathode	阴极
2	G	Gate	控制极
3	A	Anode	阳极
4		Tab	散热片

3-Leads Plastic Packaging

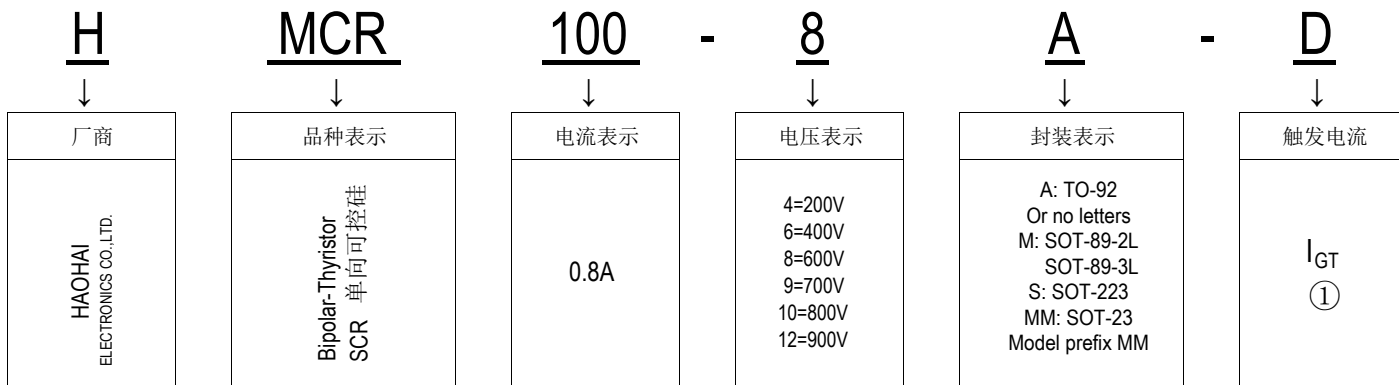
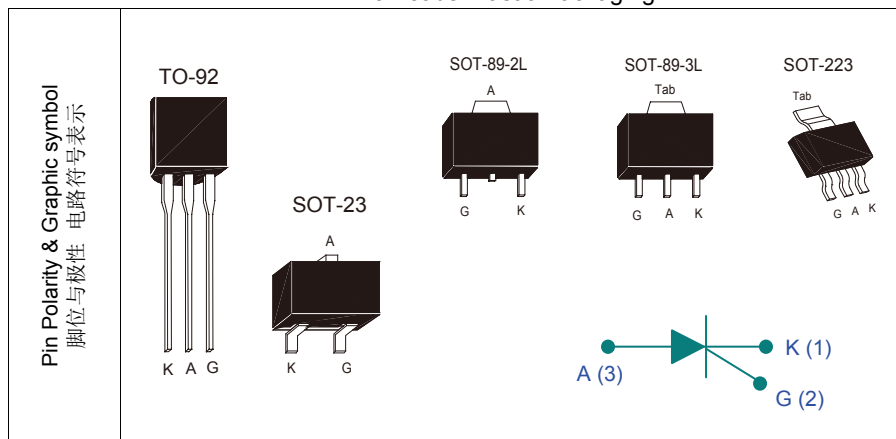

I_{GT} Class 触发电流分段 ①

Item	A	B	C	D	E	F	G	H	J	K	Unit
I _{GT}	1~5	5~10	10~30	30~60	40~100	50~200	1~10	20~40	30~45	40~200	μA

■ ABSOLUTE RATINGS (Limiting Values) 【额定值参数】

SYMBOL	Parameter & Test Conditions		Value	Unit
$I_{T(RMS)}$	On-State RMS Current	180°C Conduction Angles, $T_C=77^\circ\text{C}$	0.8	A
$I_{T(AV)}$	average on-state current		0.5	
I_{TSM}	Peak Non-Repetitive Surge Current	$T_j=25^\circ\text{C}$, $t_p=10\text{mS}$	9	
		$T_j=25^\circ\text{C}$, $t_p=8.3\text{mS}$	10	
I_{GM}	Forward Peak Gate Current	$T_j=110^\circ\text{C}$, $t_p=20\mu\text{S}$	0.2	
I^2t	I^2t for fusing	$t=10\text{mS}$	0.415	A^2ses
$P_{G(AV)}$	Forward Average Gate Power	$T_j=110^\circ\text{C}$	0.1	
V_{DRM}	Peak Repetitive Off-State Voltage ($T_j=25^\circ\text{C}$)	见参考特性对应说明 See Reference Feature Description	400~900	V
V_{RRM}	Peak Repetitive Peak Reverse Voltage ($T_j=25^\circ\text{C}$)			
T_j	Operating Junction Temperature Range		-40~+110	°C
T_{stg}	Storage Temperature Range		-40~+150	
T_L	Maximum Lead Temperature for Soldering Purposes 1/8, from Case for 10 Seconds		260	

■ ELECTRICAL CHARACTERISTICS ($T_j=25^\circ\text{C}$ Unless Otherwise Noted)

SYMBOL	Parameter & Test Conditions		Min	Typ	Max	Unit
I_{GT}	$V_D=6\text{V}$, $R_L=100\Omega$	$T_j=25^\circ\text{C}$	--	40	200	μA
I_H	Holding Current	$I_T=50\text{mA}$, $R_{GK}=1\text{K}\Omega$	--	--	5	mA
I_L	Latching Current	$I_G=1\text{mA}$, $R_{GK}=1\text{K}\Omega$	--	--	6	
V_{GT}	Gate Trigger Voltage	$V_D=6\text{V}$, $R_L=100\Omega$	--	0.6	0.8	V
V_{GD}	Gate Non-Trigger Voltage	$V_D=V_{DRM}$, $R_L=3.3\text{K}\Omega$, $T_j=110^\circ\text{C}$	0.2	--	--	
V_{TM}	Peak Forward On-State Voltage	$I_{TM}=1\text{A}$, $t_p=380\mu\text{S}$, $T_j=25^\circ\text{C}$	--	1.3	1.7	
I_{DRM}	Peak Reverse Blocking Current ($V_D=V_{DRM}$, $R_{GK}=1\text{K}\Omega$)	$T_j=25^\circ\text{C}$	--	--	5	μA
		$T_j=110^\circ\text{C}$	--	--	0.1	
I_{RRM}	Peak Reverse Blocking Current ($V_R=V_{RRM}$, $R_{GK}=1\text{K}\Omega$)	$T_j=25^\circ\text{C}$	--	--	5	
		$T_j=110^\circ\text{C}$	--	--	0.1	

■ DYNAMIC CHARACTERISTICS

SYMBOL	Parameter & Test Conditions		Min	Typ	Max	Unit
dv/dt	$V_D=67\%V_{DRM}$, $R_{GK}=1\text{K}\Omega$, $T_j=110^\circ\text{C}$		10	--	--	$\text{V}/\mu\text{s}$

■ THERMAL CHARACTERISTICS

SYMBOL	Parameter & Test Conditions		Min	Typ	Max	Unit
$R_{th(j-c)}$	Thermal Resistance-Junction-to-Case	TO-92	--	--	75	$^\circ\text{C}/\text{W}$

Voltage Current Characteristic of SCR 可控硅电压电流特性

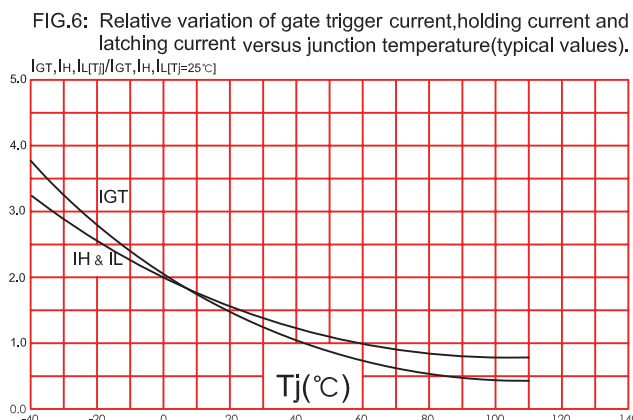
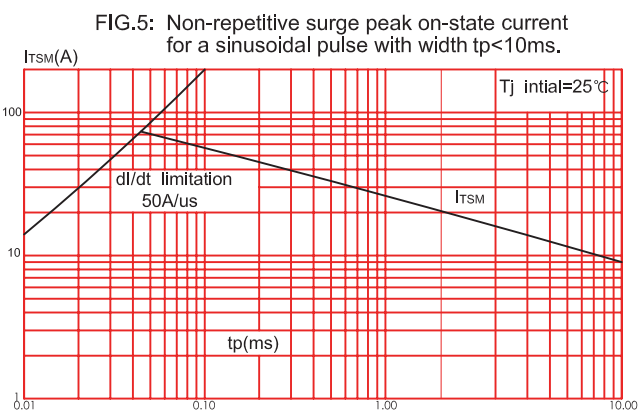
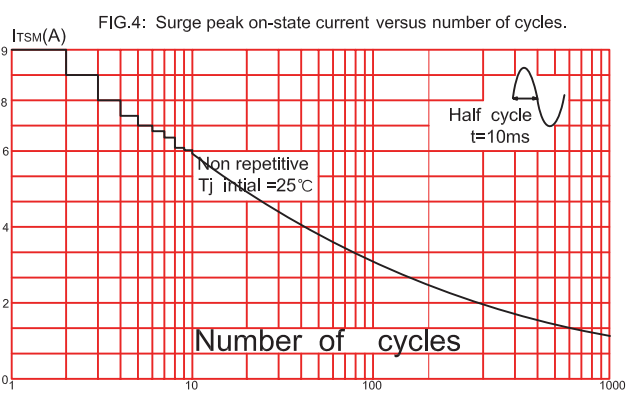
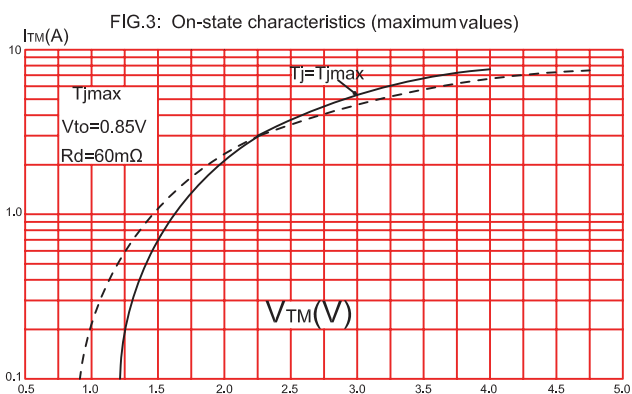
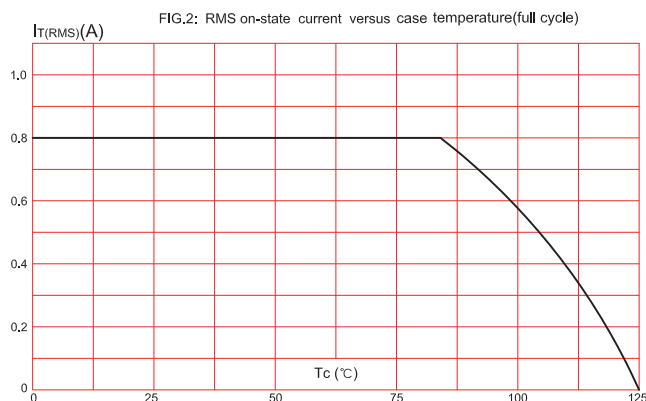
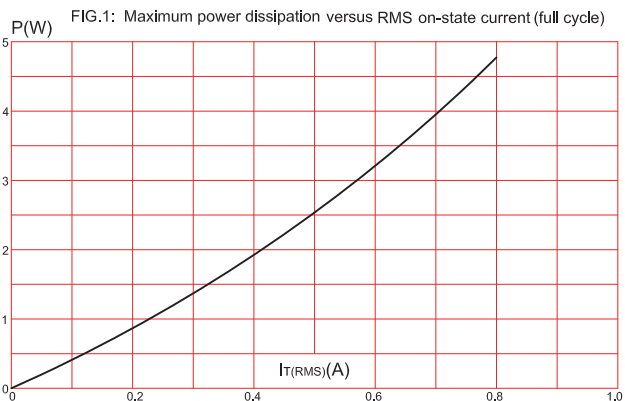

PACKAGE MECHANICAL DATA (mm) 封装尺寸数据 (毫米)

打印标识

TO-92 (TO-226AA)
Package Code: A

REF	Millimeters	
	Min.	Max.
A	4.45	5.20
B	4.32	5.33
C	3.18	4.19
D	0.407	0.533
G	1.15	1.39
H	2.42	2.66
J	0.39	0.50
K	12.70	
N	2.04	2.66
P		2.54
V	3.43	

Marking

MCR100-8: Part Number
KKG: Registered trademark
106: Chip Code
LOGO in
The upper left corner mark
MCR100-8: 产品型号
KKG: 注册商标
106: 芯片代码
左上角为公司LOGO

SOT-223
Package Code: S

REF	Millimeters	
	Min.	Max.
A	1.50	1.80
A1	0.01	0.10
B	2.90	3.10
B1	0.60	0.80
C	0.22	0.32
D	6.30	6.70
E	3.30	3.70
F	4.60 TYP.	
F1	2.30 TYP.	
G	0.70	1.10
H	1.50	2.00
J	6.70	7.30
K	0.90 TYP.	

Marking

H: HAOHAI
MCR100-8S: Part Number
KKG: Registered trademark
LOGO in
The upper left corner mark
MCR100-8S: 产品型号
KKG: 注册商标
左上角为公司LOGO

■ Packaging Specifications (包装数量、包装规格、装箱规格、包装尺寸数据)

REF.	TO-92 (TO-226AA)			SOT-223		
	Bag	BOX	Carton	Reel	BOX	Carton
QTY	1,000 Pcs	10,000 Pcs	100,000 Pcs	2,500 Pcs	5,000 Pcs	40,000 Pcs
Size	--	245×176×97mm	520×370×270mm	13"	336×336×46mm	440×440×600mm

PACKAGE MECHANICAL DATA (mm) 封装尺寸数据 (毫米)

打印标识

REF	Millimeters	
	Min.	Max.
A	0.37	0.43
B	0.50	0.60
C	1.25	1.35
D	0.50	0.60
E	2.35	2.45
F	1.85	1.95
G	2.85	2.95
H	0.60	
J	0.95	1.05
K	9°	
L	0.1	
M	6°	
O	0.02	0.10
P	0.08	
R	0.06	0.10
S	0.06	0.10
T	0.085	0.13
U	0.35	0.48
V	0.25	

SOT-23
Package Code: MM

Marking

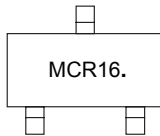

MCR16.

MMCR100-6:
MCR16 or 06E
MMCR100-8:
MCR18 or 08E
".": Chip Size Code
Conventional varieties
not marked
打印标识
MMCR100-6:
MCR16 或 06E
MMCR100-8:
MCR18 或 08E
".": 芯片标记
常规品种无标记

REF	Millimeters	
	Min.	Max.
A	1.050	1.250
A1	0	0.100
A2	1.050	1.150
b	0.300	0.500
c	0.100	0.200
D	2.820	3.020
E	1.500	1.700
E1	2.650	2.950
e	0.950 BSC	
e1	1.800	2.000
L	0.300	0.600
θ	0°	8°

SOT-23-3L
Package Code: MM

Marking

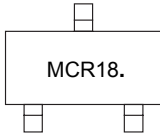

MCR18.

MMCR100-6:
MCR16 or 06E
MMCR100-8:
MCR18 or 08E
".": Chip Size Code
Conventional varieties
not marked
打印标识
MMCR100-6:
MCR16 或 06E
MMCR100-8:
MCR18 或 08E
".": 芯片标记
常规品种无标记

■ Packaging Specifications (包装数量、包装规格、装箱规格、包装尺寸数据)

REF.	SOT-23			SOT-23-3L		
	Reel	BOX	Carton	Reel	BOX	Carton
QTY	3,000 Pcs	45,000 Pcs	180,000 Pcs	3,000 Pcs	45,000 Pcs	180,000 Pcs
Size	7"	220×220×200mm	440×440×230mm	7"	220×220×200mm	440×440×230mm

PACKAGE MECHANICAL DATA (mm) 封装尺寸数据 (毫米)

打印标识

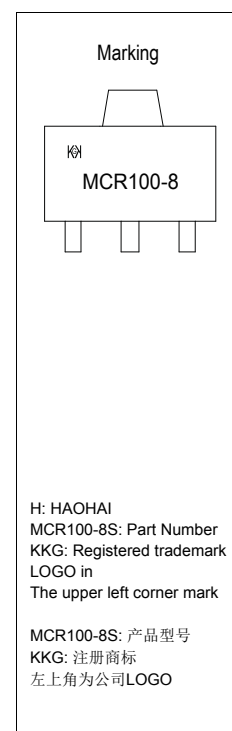
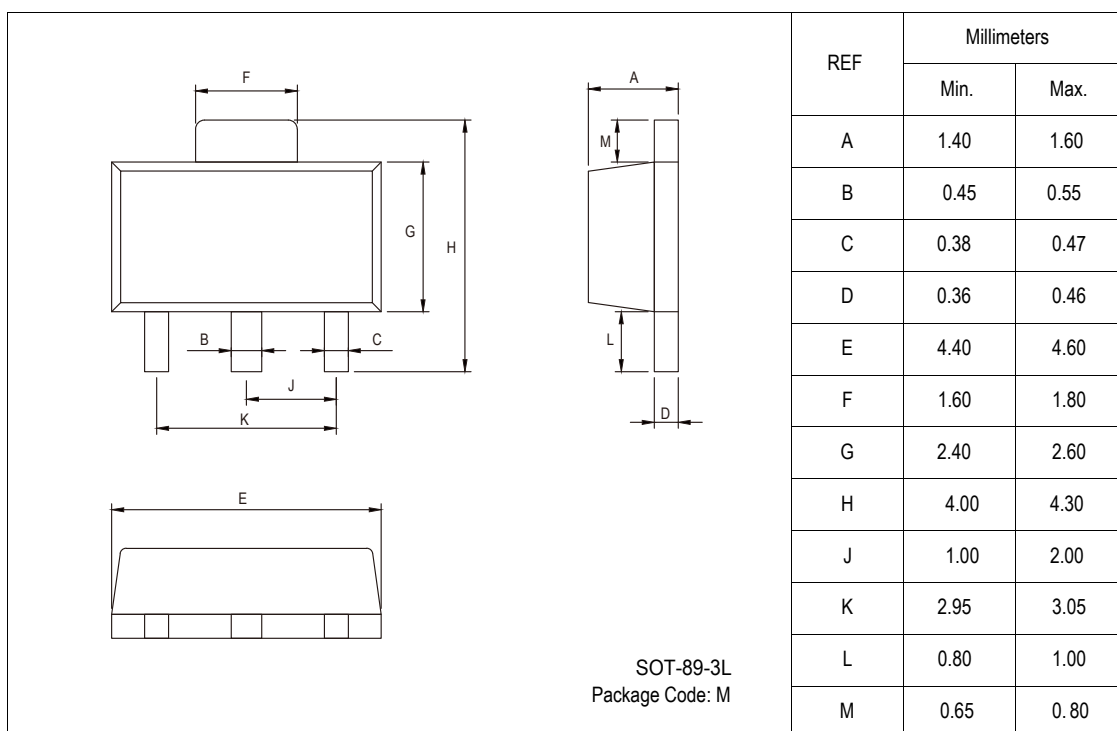
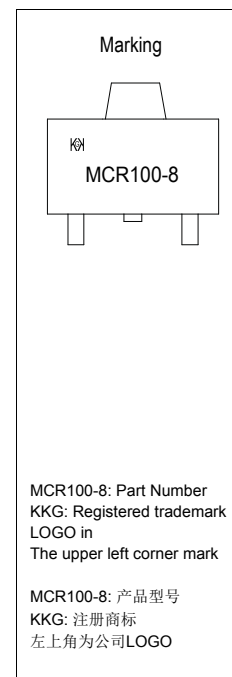
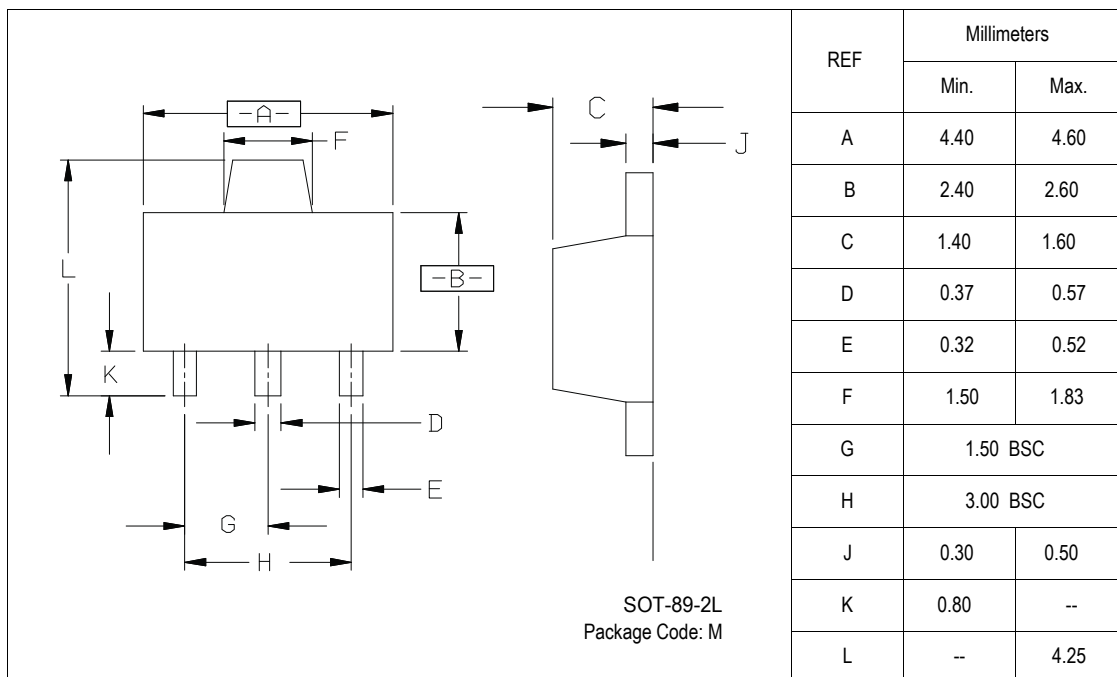

■ Packaging Specifications (包装规格、装箱规格、包装尺寸数据)

REF.	SOT-89-2L			SOT-89-3L		
	Reel	BOX	Carton	Reel	BOX	Carton
QTY	1,000 Pcs	10,000 Pcs	40,000 Pcs	1,000 Pcs	10,000 Pcs	40,000 Pcs
Size	7"	210 × 210 × 220mm	460 × 450 × 240mm	7"	210 × 210 × 220mm	460 × 450 × 240mm

Manufacturers version information
2012-04-18, KKG™ Product Data-1.0
2014-04-18, KKG™ Product Data-1.1
2017-11-18, KKG™ Product Data-1.2



经中华人民共和国工商行政管理总局商标局批准
KKG 图案、字母、均为我公司正式注册商标，仿冒、盗用均属侵权，违法必究！
WARN, Letters, patterns, are officially registered my trademark counterfeiting, theft are all violations, violators will be held liable!

深圳市浩海电子有限公司
SHENZHEN HAOHAI ELECTRONICS CO., LTD.

公司电话 TEL: +86-755-29955080、29955081、29955082、29955083
FAX: +86-755-27801767 E-mail: kkg@kkg.com.cn
产品主页: <http://www.szhhe.com> <http://www.kkg.com.cn>